

# ABL

Software revision 8.01.170127 - 2285D



**Easy Reference:**

Model name of the scale:	
Serial number of the unit:	
Software revision number (Displayed when power is first turned on):	
Date of Purchase and Address:	
Name and address of the supplier:	

**CONTENT**  
**PN 7.00.6.6.0398. Rev 2, July 2017**

<b>1.0</b>	<b>POSITIONING THE INSTRUMENT</b>	<b>4</b>
1.1	<i>Preface</i>	4
1.2	<i>Recommended location to install the instrument</i>	4
<b>2.0</b>	<b>RECOMMENDATIONS FOR A CORRECT USE OF THE INSTRUMENT</b>	<b>5</b>
2.1	<i>Preface</i>	5
2.2	<i>First power on</i>	5
2.3	<i>Using the balance</i>	5
2.4	<i>Care and cleaning of the balance</i>	6
<b>3.0</b>	<b>UNPACKING / PACKING</b>	<b>6</b>
<b>4.0</b>	<b>ABL OVERVIEW</b>	<b>7</b>
4.1	<i>Front Balance view</i>	7
4.2	<i>Rear balance view</i>	7
<b>5.0</b>	<b>KEYBOARD AND DISPLAY</b>	<b>8</b>
<b>6.0</b>	<b>OPERATION</b>	<b>9</b>
6.1	<i>Weighing pan component location</i>	9
6.2	<i>Connecting the balance to the electronics box</i>	9
6.3	<i>Connection between power supply and electronics box</i>	9
6.4	<i>Balance levelling</i>	10
6.5	<i>Switch on</i>	11
<b>7.0</b>	<b>WEIGHING</b>	<b>12</b>
7.1	<i>Stand by</i>	12
7.2	<i>Simple weighing</i>	12
<b>8.0</b>	<b>CALIBRATION</b>	<b>13</b>
8.1	<i>Balances with external calibration</i>	13
8.2	<i>Balances with internal calibration</i>	15
<b>9.0</b>	<b>TARE FUNCTION</b>	<b>16</b>
9.1	<i>Manual tare function</i>	17
<b>10.0</b>	<b>BALANCE PARAMETERS / SETUP MENU</b>	<b>18</b>
10.1	<i>Weighing units</i>	19
10.2	<i>Serial output setup</i>	20
10.3	<i>Transmission speed selection</i>	21
10.4	<i>Autozero function</i>	21
10.5	<i>Filter selection</i>	22
10.6	<i>Stability function</i>	23
10.7	<i>Contrast adjustment</i>	24
10.8	<i>Backlight settings</i>	25
10.9	<i>Timer-off function</i>	26
10.10	<i>Date and time settings</i>	27
10.11	<i>Language selection</i>	28
10.12	<i>Calibration setting mode</i>	29
10.12.1	<i>Automatic calibration (AUT-CAL)</i>	30

10.12.2	<i>Internal calibration (I-CAL) [locked for verified balances]</i>	31
10.12.3	<i>External calibration (E-CAL) [locked for verified balances]</i>	31
10.12.4	<i>Technical calibration (TEC-CAL) [locked for verified balances]</i>	31
10.13	<b>CALIBRATION DATA</b>	33
<b>11.0</b>	<b>BALANCE PROGRAMS MENU</b>	34
11.1	<i>Piece counting function</i>	35
11.1.1	<i>Manual insertion of the average unit weight</i>	37
11.1.2	<i>Automatic updating of the average unit weight</i>	39
11.2	<i>Program for the determination of the density of a solid or a liquid</i>	39
11.2.1	<i>Solid density determination</i>	39
11.2.2	<i>Liquid density determination</i>	42
11.3	<i>Formulation function</i>	44
11.3.1	<i>Manual formulation</i>	44
11.3.2	<i>Formula saving</i>	46
11.3.3	<i>Formula recall</i>	48
11.4	<i>Max-min thresholds function</i>	50
11.5	<i>Percentage weighing function</i>	52
11.5.1	<i>Automatic mode with reference weight</i>	53
11.5.2	<i>Mode with manual insertion of the reference weight</i>	54
11.6	<i>Animal weighing function</i>	55
11.7	<i>Maximum load function</i>	56
11.8	<i>GLP function (good laboratory practices)</i>	57
<b>12.0</b>	<b>RS232 INTERFACE FEATURES</b>	59
12.1	<i>General features</i>	59
12.2	<i>Diagram of connector</i>	59
12.3	<i>Connection of the balance to a computer</i>	60
12.3.1	<i>Continuous transmission mode</i>	61
12.3.2	<i>On demand transmission mode</i>	61
12.3.3	<i>On demand transmission with GLP</i>	63
12.4	<i>Connection of balance with serial printer</i>	63
12.4.1	<i>Print formats</i>	64
12.4.2	<i>Generic printer or TLP 50 printer with GLP</i>	65
<b>13.0</b>	<b>ERROR CODES</b>	66
<b>14.0</b>	<b>MAINTENANCE AND CARE</b>	67
<b>15.0</b>	<b>QUICK GUIDE TO BALANCE PARAMETER'S SETUP</b>	68
<b>16.0</b>	<b>BALANCE TECHNICAL CHARACTERISTICS</b>	69

**WARNING:**



Please read carefully following instructions for installation and use before starting your work with a new balance. Failure to use the balance in accordance with the advice in the user manual could mean that the product gives incorrect readings..

## **1.0 POSITIONING THE INSTRUMENT**

### **1.1 PREFACE**

Balances with resolutions of 0.1mg and 0.01mg are instruments of high sensitivity and precision. To achieve reliable and accurate results, it is fundamental to install the instrument in a suitable environment to meet the requirements necessary to ensure its proper function.

### **1.2 RECOMMENDED LOCATION TO INSTALL THE INSTRUMENT**

Selection of the correct location for the instrument is fundamental to ensure optimal and precise operation.

**For optimum weighing it is necessary to respect the following criteria:**

#### **TYPE OF ENVIRONMENT**

- Place the balance in a corner of the room to minimize vibrations.
- Place the balance in a secluded location: do not put it near doors, to prevent air drafts.
- Avoid places with several people: each person who is close to the balance generates a draft of air which can affect the weighing performance.
- Protect the balance from air conditioning or ventilation fans and other electronic devices with fans (e.g. Computer or other laboratory instruments).
- Keep the room temperature as constant as possible, at a value between 15 and 30°C.
- Keep the humidity (where the balance is used) as constant as possible. Humidity should be maintained between 40% RH and 65% RH of moisture.
- Place the balance away from heat sources, e.g. heaters, light bulbs (use tubular lamps), windows (the warmth of the sun's rays can filter out the window and may affect the weighing result).

#### **TYPE OF WEIGHING TABLE**

- The table must be stable. It must not sag during placement of the instrument (e.g. Laboratory bench or marble / granite counter top).
- Must be as anti-magnetic and anti-static as possible.
- Must only be used for the balance.
- Place the balance as close as possible to the table legs because there are less vibrations rather than in the middle of the table.
- The best table to use is Adam Anti – Vibration Table, details of which can be provided by your supplier.

## 2.0 RECOMMENDATIONS FOR A CORRECT USE OF THE INSTRUMENT

### 2.1 PREFACE

In order to obtain accurate and repeatable weighing, please pay attention to the following.

### 2.2 FIRST POWER ON

- The first time that you connect the balance to the mains, before use, wait at least 12 hours to ensure the instrument is fully warmed up.
- For a correct use of the instrument, never disconnect the balance from the mains. If you want to turn it off, use the ON / OFF button to put it in Stand-by. This ensures it is not necessary to wait 12 hours each time for the balance to warm up.

### 2.3 USING THE BALANCE

- Level the balance. It is vital, for correct weighing operation, to always level the instrument: regularly check that the bubble is at the center of the spirit level. Adjust then and lock the feet to ensure the correct levelling of the balance.
- Always load the sample in the center of the pan to avoid possible errors.
- Only open the glass doors of the weighing chamber when necessary, and use tweezers to load/unload the samples to be weighed, to avoid contamination of the sample.
- Pay attention to possible static charges, the static may occur due to containers made from materials of low electrical conductivity or due to dry air with less than 40% moisture. Electrostatic charges can alter the results of the weighing. It is recommended to use the Adam Ioniser ABI-1 to eliminate static charges present on any substances to be weighed or that have accumulated on the instrument. Because of static charges the results of weighings are always different and the balance is not repeatable.
- Pay attention to **dynamic push**: a big **temperature** difference between the sample to be weighed and the weighing chamber creates air drafts along the sample. A colder object appears heavier while a warmer object lighter, this effect is reduced when it is reached the thermal equilibrium between sample and weighing chamber.

With dynamic push you will get results that move in one direction depending on whether the material is colder or warmer.

- Pay attention to substances that can evaporate (alcohol) or absorb humidity (silicone gel), because with these types of materials weight may vary constantly in one direction.
- Be careful to magnetic materials, as magnetic objects will attract each other and the force that results will be wrongly interpreted as a load.  
With magnetic materials the weighing results are hardly repeatable, the indication remains stable but weighing result provides different results.

## 2.4 CARE AND CLEANING OF THE BALANCE

- Before cleaning, remove all removable parts (e.g. Plate, underplate).
- To clean the weighing chamber, the plate, the glasses and the other parts please use an antistatic liquid (do not use a cloth that can leaves fragments).

## 3.0 UNPACKING / PACKING

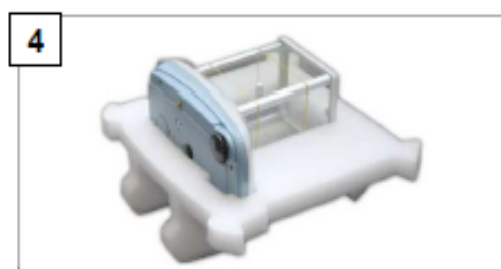

Open the top face of the box; you will find the accessories box containing: User manual, Pan, Pan Support, Anti-breeze ring, Power Supply, Power Supply Box. Unpack the balance on a flat surface so that the removal of inner protection foam is easier.

**Note: Keep all packing parts in case of balance return and always use original packing in case the balance needs returning to the service center to avoid damages to the instrument.**

## 4.0 ABL OVERVIEW

### 4.1 FRONT BALANCE VIEW

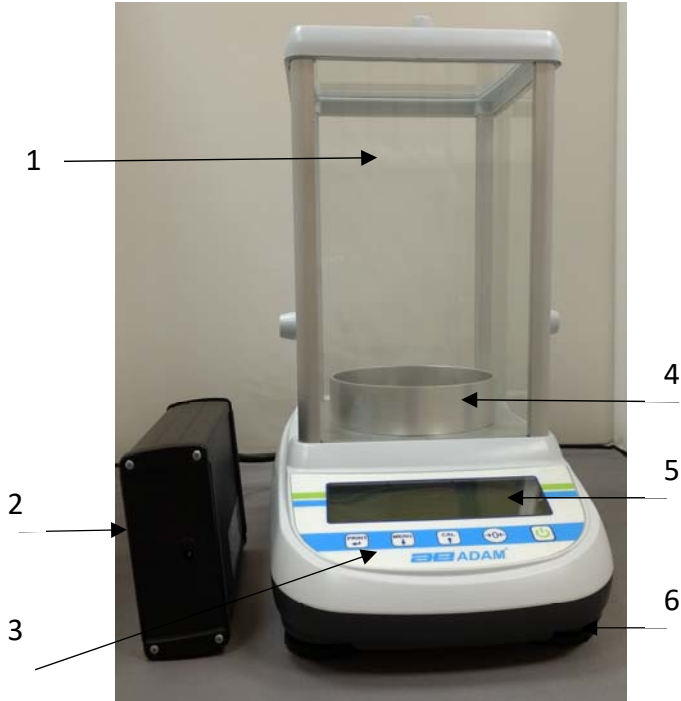

1 Draft windshield

2 Electronics box

3 Keyboard

4 Antiventilation ring

5 Display LCD

6 Adjustable front foot

### 4.2 REAR BALANCE VIEW

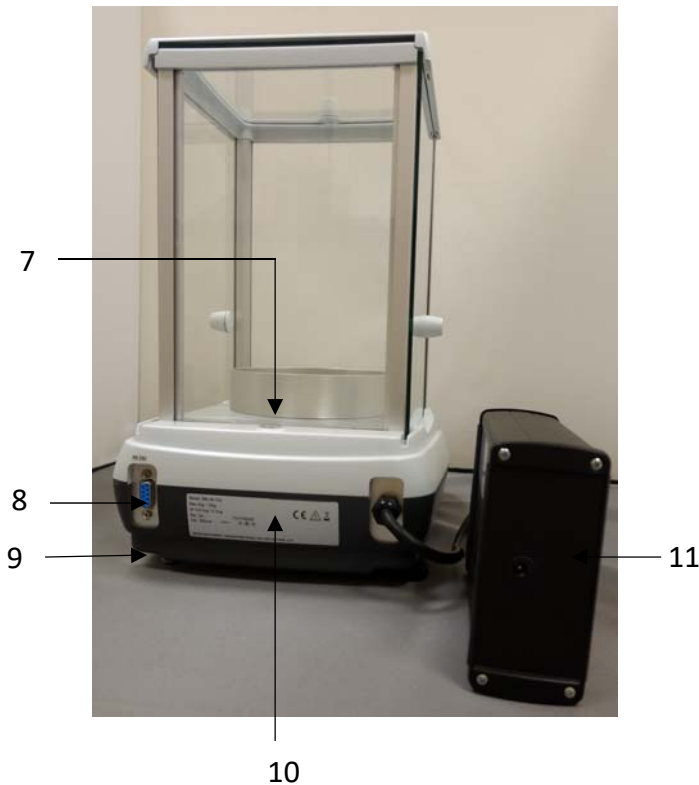

7 Spirit Level

8 Connector 9 pin female RS232 interface for printer/ PC.

9. Rear fixed foot

10. Label with balance model and serial number.

11. Power socket



## 5.0 KEYBOARD AND DISPLAY

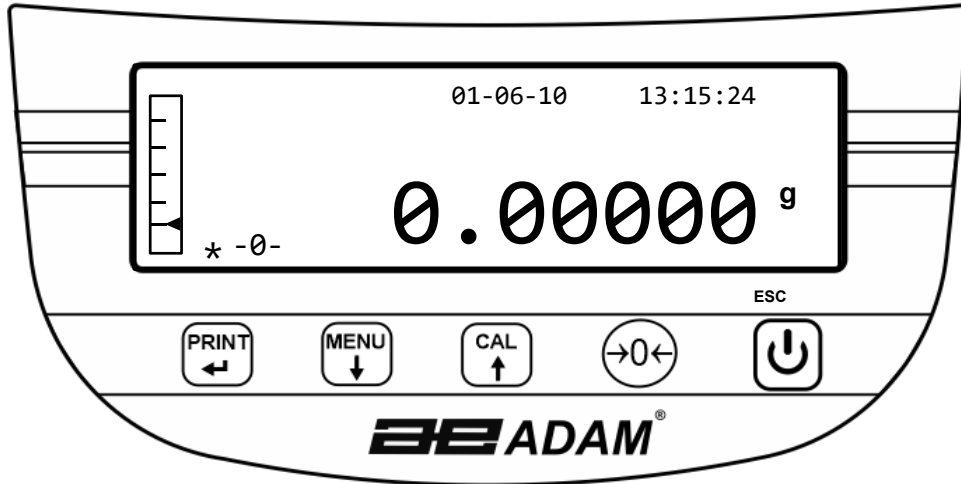

Selection CONFIRM or SEND data to the printer button



Button for accessing the MENU to set the balance's parameters



Balance CALIBRATION button



TARE and zeroing button



Standby (OFF) or operating (ON) button or ESC

\* Stability indicator

O Zero indicator

% Percent weight

PC Piece counting

 Battery indicator

▼ Data insertion mode

H Upper threshold

L Lower threshold

DS Density measurement

ct, Unit of measurement

## 6.0 OPERATION

### 6.1 WEIGHING PAN COMPONENT LOCATION

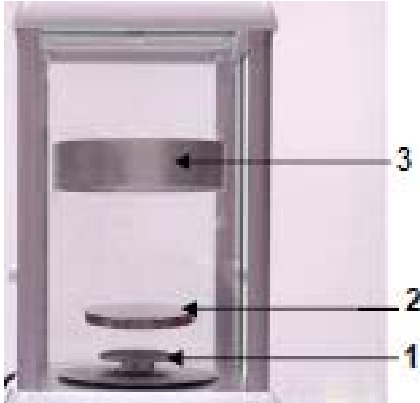

**Note: Scales with capacity 0.01mg on the pan Support and the Weighing Pan is in one piece**



1. Place Pan Support on balance cone taking care to locate correctly.
2. Fit Weighing Pan on pan support and check the pan is located correctly.
3. Fit Anti-ventilation ring ensuring it clears the pan edges.

### 6.2 CONNECTING THE BALANCE TO THE ELECTRONICS BOX

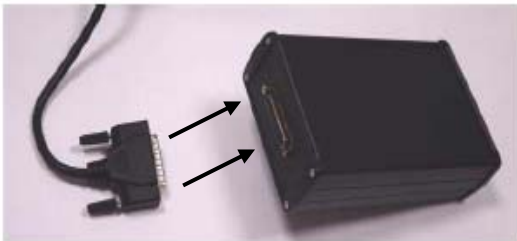

- Insert plug connection cable into jack of electronic box
- Fix the connector securely by screwing the two side screws

### 6.3 CONNECTION BETWEEN POWER SUPPLY AND ELECTRONICS BOX



- Insert power supply connector in DC plug placed on electronics box
- Use only power supply provided with the balance

## 6.4 BALANCE LEVELLING

- **Level** the balance with the adjustable feet using the spirit level, adjusting it until the bubble is located at the centre of the spirit bubble indicator.



- **Adjust** the balance according to the spirit level bubble.
- **Lift** the balance - rotate front feet clockwise
- **Lower** the balance - rotate feet anticlockwise.
- Once level bubble is displaying properly using adjustable feet ( **2** ), lock them screwing the disk Foot-locking ( **3** )



## 6.5 SWITCH ON

After connecting the balance to power supply, a self-diagnosis of electronic circuits is automatically carried out, ending with stand by indication.



**Balance Warm-up: Wait** 12 hours from switch on for warm up

**It is recommended to never disconnect the balance from the power socket and use the ON/OFF key to put the instrument in standby mode when you finish using it.**

From the **“STAND BY”** mode: to bring the balance back to working conditions, press **ON/OFF** key.



It is recommended not to drop heavy objects on balance pan, to avoid damage of the instrument.

In order to get precise measurements, balance has to be adjusted to the environmental conditions. This adjustment is accomplished through calibration function.

You must calibrate the balance every time it is moved to different place.

## 7.0 WEIGHING

After having connected the balance to the correct power supply, a self-diagnosis of the electronic circuits is automatically carried out, that ends with the standby indication.



### 7.1 STAND BY

From the “**STAND BY**” state:

- Press the **ON/OFF** button to bring the balance to weighing mode.
- Press the **ON/OFF** button again to bring it back to the “**STAND BY**” state.
- 

### 7.2 SIMPLE WEIGHING

Place the sample to be weighed on the plate and read the value of the item on the display as soon as the asterisk stability symbol ✱ appears.

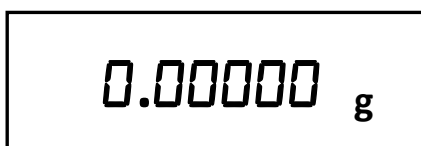

## 8.0 CALIBRATION

The electronic balance carries out mass measurements using gravity. Differences in geographical regions and altitudes vary the gravitational acceleration.

The balance must therefore be adapted to environmental conditions to obtain accurate measurements. This regulation is carried out through the calibration function.

### 8.1 BALANCES WITH EXTERNAL CALIBRATION

The calibration is carried out through pressing the CAL button.

1. Press the **CAL** button with the plate unloaded; the word CAL will be displayed.

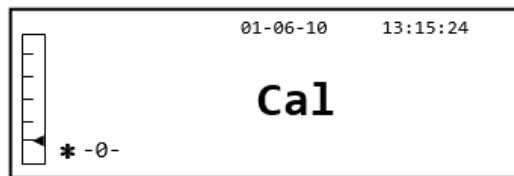

2. When the value of the calibration weight begins to flash, load the weight shown on the display onto the weighing pan.

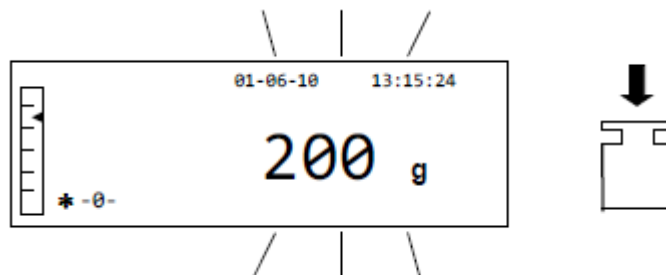

3. The display will stop flashing, indicating the value of the calibration weight with the stability indicator on.

Once the calibration has been carried out, the calibrated weight will be displayed with the indication of the current unit of measurement.

4. Remove the calibration weight. The balance is now ready for weighing operation.

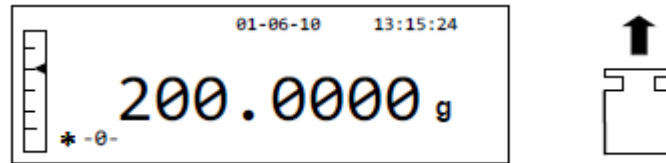

**NOTE: an error message will be displayed if there is some interference during the calibration process. To interrupt the calibration process, press the ON/OFF button while the calibration weight indication flashes.**

It is also possible to calibrate the balance with a calibration weight greater than the pre-set calibration weight:

1. Press and hold the **CAL** button with the weighing pan empty, until the beeping stops, and then release the button. The word “-CAL-“will be shown on the display, followed by the word “**LOAD**”, flashing.

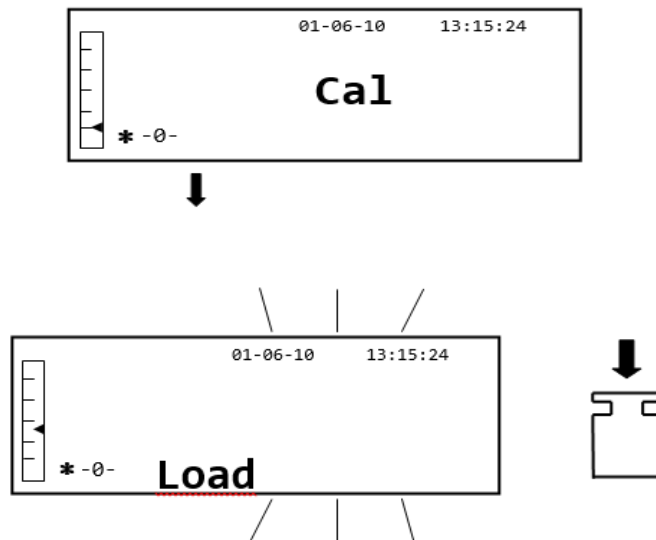

2. Load a weight that is equal to or greater than the pre-set calibration weight onto the weighing plate; the balance will recognize a weight that is equal to or greater than the calibration weight as valid provided that it is a recognised weight with respect to the most significant figure of the calibration weight.

*e.g.:* if the calibration weight is 200 g, it will be possible to calibrate the balance with values that go from 200g, 300g, 400g up to the upper capacity limit of the balance. The word “**LOAD**” on the display will stop flashing; once the calibration has been carried out, the value of the weight used will be displayed.

3. Remove the calibration weight; the balance is now ready for the weighing operation.

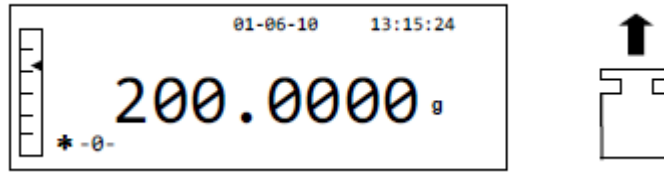

**NOTE:** an error message will be displayed if there is some interference during the calibration process. To interrupt the calibration process, press the ON/OFF button while the calibration weight indication flashes.

## 8.2 BALANCES WITH INTERNAL CALIBRATION

For models with internal calibration, the calibration process is carried out through an internal automatic system:

1. Press the **CAL** button with the plate empty.  
The display will show the message “**CAL**” and the balance’s calibration will be carried out automatically.

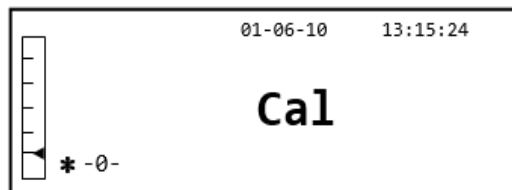

2. At the end of the calibration, the balance will return to normal weighing condition.

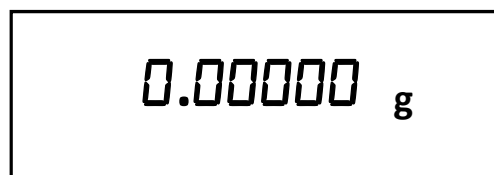

If the calibration is not completed due to vibrations or drafts, the Error message “**CAL bUT**” will be displayed. Press the CAL button again, and if the problem persists, select external calibration or contact the supplier.

To change the calibration mode in these models with internal calibration, see section 10.12.1



## 9.0 TARE FUNCTION

1. The relative weight will be shown on the display.

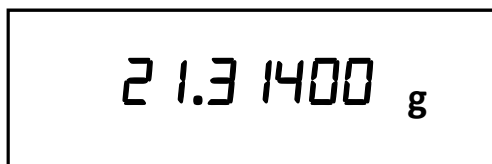

2. Press the **O/T** button. The word "Tare" will be displayed.

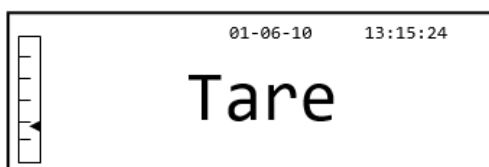

3. Once stability has been achieved, the zero value "**0.00000**" will be displayed. In case stability is not achieved due to drafts, vibrations, or other types of disturbance, the dashes will continue to be displayed.

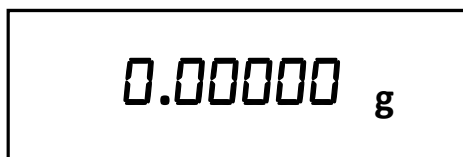

4. Put the objects to be weighed in the container. Read the value of the net weight on the display.

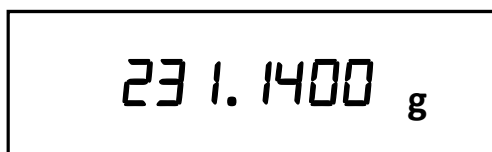

## 9.1 MANUAL TARE FUNCTION

This function allows a tare value to be entered manually.

1. Press and hold the **O/T** button with the weighing pan empty, until the beeping stops, and then release the button.
2. The following digits will be shown on the display:

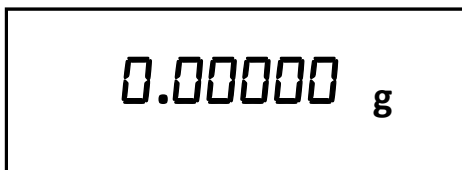

A rectangular box representing a digital display. Inside the box, the text "0.00000 g" is displayed in a bold, black, sans-serif font. The "0" is significantly larger than the other digits.

3. Now insert the desired tare value using the **CAL** and **MENU** buttons to increase or decrease the number, while pressing the **O/T** button to pass to the next number. During the entering phase, holding down the **O/T** button allows you to delete the inserted value.

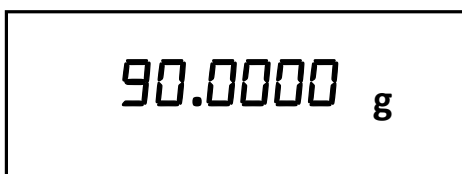

A rectangular box representing a digital display. Inside the box, the text "90.00000 g" is displayed in a bold, black, sans-serif font. The "90" is significantly larger than the other digits.

4. After having entered the desired value, press the **PRINT** button to confirm it. The value will remain in memory until the **TARE** button is pressed, or when the instrument is disconnected from the power supply.

## 10.0 BALANCE PARAMETERS SETUP MENU

1. Press and hold the **MENU** button with the weighing pan empty until the beeping stops, and then release the button.
2. The following writing will be shown on the display:

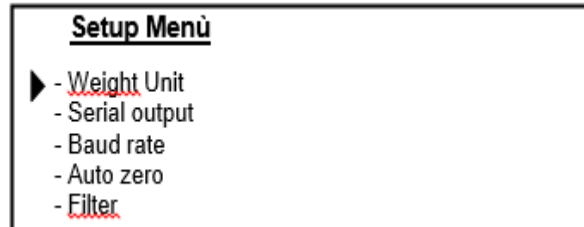

3. Now use the CAL and MENU buttons to navigate upward and downward in the parameters menu.

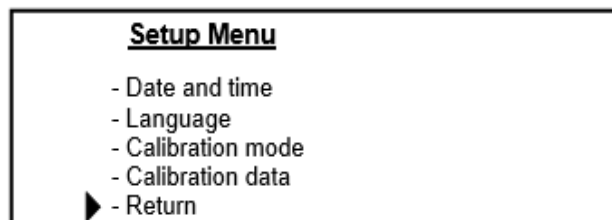
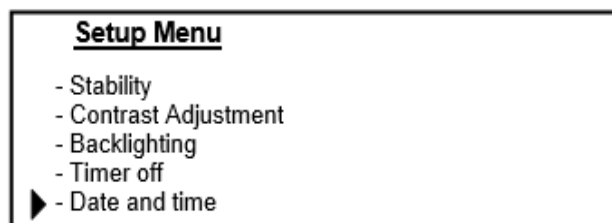
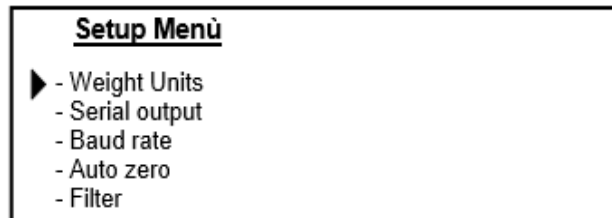

4. Position the cursor on the desired parameter and press the PRINT button to confirm the selection.
5. Press the ON/OFF button to exit from the menu or select the return function and press the PRINT button.

## 10.1 WEIGHING UNITS

The weight units with which the balance will display, can be selected.

1. Set the weight units parameter as described in chapter 10.

The current set weight unit will be shown on the display e.g.: GRAMS

2. By pressing the **MENU** or **CAL** button it will be possible to scroll through the weight units upward or downward.

3. Press the **PRINT** button to confirm the desired weighing unit.

SYMBOL	UNIT OF MEASUREMENT	CONVERSION FACTOR 1 g =
g	GRAMS	1.
<del>ct</del>	CARATS	5.
<del>oz</del>	OUNCES**	0.035273962
<del>lb</del>	POUNDS**	0.0022046226
Dwt	PENNYWEIGHTS**	0.643014931
<del>ozt</del>	TROY OUNCE**	0.032150747
GN	GRAINS**	15.43235835
t1	HONG KONG TAEI**	0.02671725
t2	SYNGAPORE TAEI**	0.02646063
t3	TAIWAN TAEI**	0.02666666
mo	MOMME**	0.2667

4. After having selected the desired weighing unit, the display will return to the original parameter menu. It will now be possible to select another parameter or return to weighing mode by pressing the **ON/OFF** button.

By returning to the weighing mode in the right part of the display, the selected weight unit will be displayed.

## 10.2 SERIAL OUTPUT SETUP

Different data transmission devices and modes can be selected.

1. Select the serial output parameter as described in paragraph 10.  
The current set transmission mode will be shown on the display:

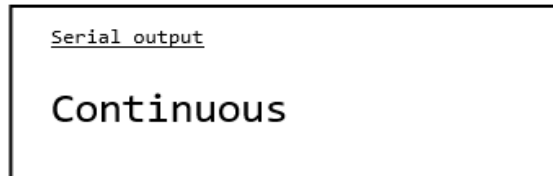

2. Now by pressing the **MENU** or **CAL** button it will be possible to scroll through the serial output **MENU** forward or backward.
3. Then press the **PRINT** button to confirm the desired transmission mode.

The different transmission modes are illustrated below:

TRANSMISSION MODE	FEATURES
Continuous	Transmits the weight data in a continuous way
On demand	Transmits the weight data only when the <b>PRINT</b> button is pressed
Generic printer	The weight data is printed only when the Busy command is active
Tlp50 printer	The weight data is printed only if the Tlp50 model printer is connected
Upon request - Glp	Transmits the weight data and the Glp information only when the <b>PRINT</b> button is pressed
Generic printer - Glp	The weight data and the Glp information are printed only when the Busy command is active
TLP – Glp printer	The weight data and the Glp information are printed only if the Tlp50 model printer is connected

**NOTE: transmission speed selection (paragraph 10.3)**

4. After having selected the desired transmission mode, the screen relative to the balance parameters menu will be displayed again. It will now be possible to select another parameter or return to weighing mode by pressing the **ON/OFF** button.

### 10.3 TRANSMISSION SPEED SELECTION

It is possible to select different data transmission speeds.

1. Select the baud rate parameter as described in paragraph 10.  
The current transmission speed will be shown on the display:

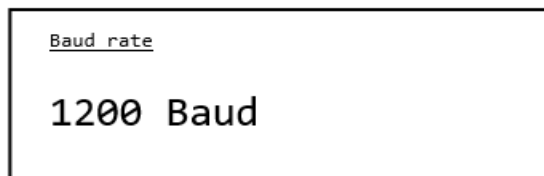

2. Select the serial data transmission speed, the options are: 1200-2400-4800-9600 baud. By pressing the **MENU** or **CAL** button you can scroll to the different transmission speeds upward or downward; then confirm the choice with the **PRINT** button.
3. After selecting the desired transmission speed, the screen will return to the balance parameter menu again. It will now be possible to select another parameter or return to weighing mode by pressing the **ON/OFF** button.

### 10.4 AUTOZERO FUNCTION

Auto-zero is the correction from a possible deviation from zero.

Different auto-zero correction values can be selected.

1. Select the auto-zero parameter as described in chapter 10.  
The auto-zero parameter will be shown on the display:

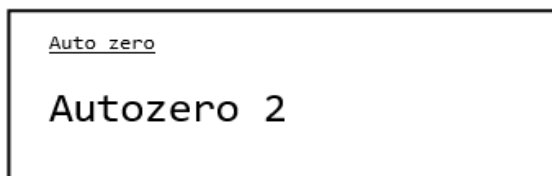

2. Select the desired auto-zero value. By pressing the **MENU** or **CAL** button it will then be possible to scroll through the various levels upward or downward, and then confirm your choice with the **PRINT** button.

AUTOZERO MENU	AUTOZERO LEVEL
Auto-zero off	Auto-zero off
Auto-zero 1	Light auto-zero
Auto-zero 2*	Average auto-zero
Auto-zero 3*	Heavy auto-zero
Auto-zero 3E*	Heavy full-scale auto-zero

3. After having selected the desired auto-zero, the screen will display the balance parameters menu again. It will now be possible to select another parameter or return to weighing mode by pressing the **ON/OFF** button.

## 10.5 FILTER SELECTION

The balance can be set to different environmental conditions by way of selecting three different filters:

1. Select the filter parameter as described in paragraph 10. The current set filter type will be shown on the display:

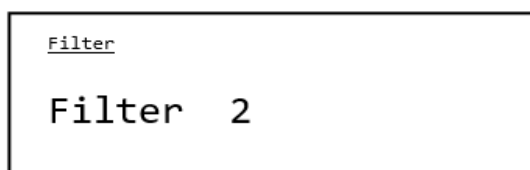

2. Select the desired filter setting by pressing the **MENU** or **CAL** button, it will then be possible to scroll through the various levels upward or downward; finally confirm your choice by selecting the **PRINT** button.

FILTER MENU	FILTER LEVEL
Filter 1	Use this filter level in a stable environmental condition and for use of the instrument in filling or dosing mode.
Filter 2	Use this filter level when the environmental conditions are not stable.
Filter 3	Use this filter level when the environmental conditions are particularly unstable.

- After selecting the desired filter value, the screen will display the balance parameters menu again. It will now be possible to select another parameter or return to weighing mode by pressing the **ON/OFF** button.

## 10.6 STABILITY FUNCTION

The stability symbol will appear on the display when the weight is stable within a defined interval.

- Select the stability parameter as described in paragraph 10.  
The current stability value will be shown on the display:

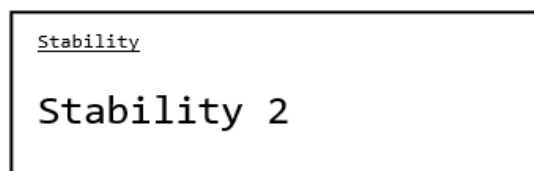

- Select the desired stability value. By pressing the **MENU** or **CAL** button, you can then scroll through the various levels upward or downward; finally confirm your choice by selecting the **PRINT** button.

STABILITY MENU	LEVEL OF STABILITY
Stability 1	Use this level of stability when the environmental conditions are stable
Stability 2	Use this level of stability when the environmental conditions are less stable
Stability 3	Use this level of stability when the environmental conditions are unstable



3. After having selected the desired value for stability, the screen will display the balance parameter menu will be displayed again. It will now be possible to select another parameter or return to weighing mode by pressing the **ON/OFF** button.

## 10.7 CONTRAST ADJUSTMENT

The balance's display is equipped with an LCD display; the contrast can be adjusted in order to make the indication as visible as possible from different angles and different light levels.

1. Select the contrast adjustment parameter as described in paragraph 10. The current set contrast value will be shown on the display:

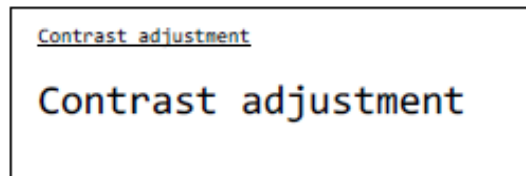

2. Select the desired contrast value. By pressing the **MENU** or **CAL** button, it will be possible to increase or decrease the value; then confirm the choice with the **PRINT** button.

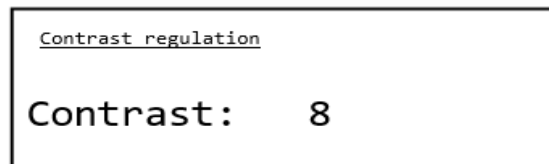

3. After selecting the desired contrast level, the screen will display the balance parameters menu again. It will now be possible to select another parameter or return to weighing mode by pressing the **ON/OFF** button.

## 10.8 BACKLIGHT REGULATION

The balance's display is equipped with a backlight to make the indication visible even in low light conditions.

1. Select the backlight parameter as described in paragraph 10. The current set mode will be shown on the display:

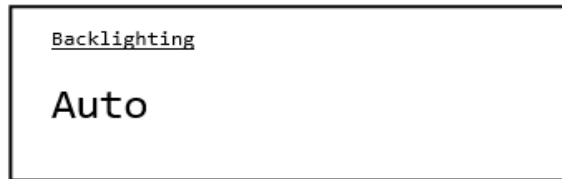

2. Select the desired backlight mode. By pressing the **MENU** or **CAL** button it will then be possible to scroll through the various levels upward or downward; then confirm the choice with the **PRINT** button.

BACKLIGHT MENU	BACKLIGHT MODE
Auto	Backlight automatically active during the weighing phases
On	Backlight always on
Off	Backlight always off

3. After having selected the desired mode, the screen will display the balance parameters menu again. It will now be possible to select another parameter or return to weighing mode by pressing the **ON/OFF** button.

## 10.9 TIMER-OFF FUNCTION

This function allows you to activate the automatic power down of the balance after a preset time of inactivity.

1. Select the Timer off parameter as described in paragraph 10. The current set value will be shown on the display:

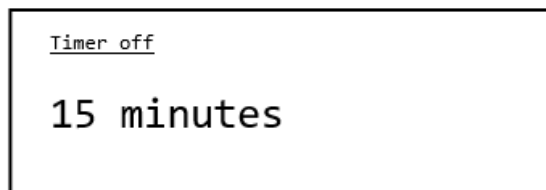

2. Select the desired auto-off mode. By pressing the **MENU** or **CAL** button it will be possible to scroll the various levels upward or downward and then confirm the choice with the **PRINT** button.

TIMER-OFF MENU	AUTO OFF MODE
Disabled	Timer-off disabled
2 minutes	Timer-off after 2 minutes of inactivity
5 minutes	Timer-off after 5 minutes of inactivity
15 minutes	Timer-off after 15 minutes of inactivity

**NOTE:** In balances equipped with an internal battery, it is recommended not to disable the Timer-off mode in order to prolong battery life.

3. After having selected the desired mode, the screen will display the balance parameters menu again. It will now be possible to select another parameter or return to weighing mode by pressing the **ON/OFF** button.

## 10.10 DATE AND TIME SETTINGS

This function allows you to set the date and time, and to modify the date display format.

1. Select the date and time parameter as described in paragraph 10. The current set date and time will be shown on the display:

```
Date and time
Format: dd-mm
10-06-10 12:03:10
```

2. Select the desired format of the date. Pressing the **MENU** or **CAL** button it will be possible to modify the format dd-mm or mm-dd; then confirm the choice with the **PRINT** button.

```
Date and time
Format: dd-gg
06-10-10 12:03:10
```

3. Set the desired date and time by using the **MENU** and **CAL** buttons to increase and decrease the number and the **PRINT** button to pass to the next date.

```
Date and time
Format: dd-gg
06-10-10 12:03:10
```

4. After date and time have been set, press and hold the **PRINT** button until the beeping stops and then release the button to save the settings.
5. The screen relative to the balance parameters menu will then be displayed. It will now be possible to select another parameter or return to weighing mode by pressing the **ON/OFF** button.

## 10.11 LANGUAGE SELECTION

This function allows you to set the desired language.

1. Select the language parameter as described in paragraph 10. The language currently set will be shown on the display:



2. Select the desired language. By pressing the **MENU** or **CAL** button it will be possible to scroll the various levels upward or downward; then confirm your choice with the **PRINT** button.

LANGUAGE MENU	LANGUAGE
Italian	Italian language
English	English language
Português	Portuguese language
Deutsch	German language
Français	French language
Español	Spanish language

After having selected the desired language, the screen relative to the balance parameters menu will be displayed again. It will now be possible to select another parameter or return to weighing mode by pressing the **ON/OFF** button.

## 10.12 CALIBRATION SETTING MODE

This function allows you to set the calibration mode. *This function is only available for the models equipped with internal calibration* (not available for all models). To check if the instrument is equipped with internal calibration mode, refer to the table of technical features, chapter 18.

1. Select the calibration mode parameter as described in paragraph 10. The calibration mode currently set will be shown on the display:

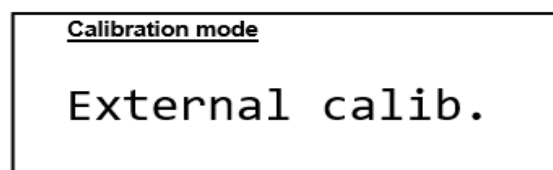

2. Select the desired mode. By pressing the **MENU** or **CAL** buttons it will be possible to scroll the different calibration modes upward or downward:
  - External calibration
  - Internal calibration
  - Automatic calibration
  - Technical calibration
3. Press the **PRINT** button to confirm "**AUT-CAL**", "**I-CAL**", "**E-CAL**".  
To confirm "**TEC-CAL**", keep the **PRINT** button pressed until the beeping stops.
4. The screen will display the balance parameters menu. It will now be possible to select another parameter or return to weighing mode by pressing the **ON/OFF** button.

### 10.12.1 Automatic calibration (AUT-CAL)

The balance self-calibrates when the temperature variation exceeds the factory pre-set value and at the factory pre-set time intervals, through the internal reference mass, and only if the balance pan is empty.

When the balance needs to perform the automatic calibration, the display will show the following message:

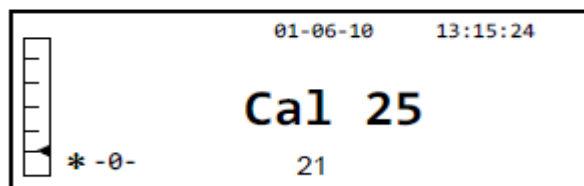

A 25-seconds countdown will start during which you can decide to:

- Stop the automatic-calibration procedure by pressing the “**ON/OFF**” button that will be delayed of 5 minutes.

or

- Let the countdown finish so that the automatic calibration starts.

**Note: during the countdown do NOT load anything on the weighing pan!**

In this mode, it is also possible to carry out the calibration with the internal reference mass by pressing the **CAL** button at any moment, first ensuring that no weight is loaded on the weighing pan.

1. Press the **CAL** button with the pan empty. The display will show the message “**CAL**” and the balance’s calibration will be carried out automatically.

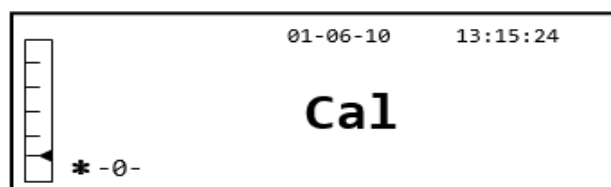

2. At the end of the calibration, the balance will return to normal weighing condition.



If the calibration is not completed due to vibrations or drafts, the message “**CAL bUt**” will be displayed. Press the **CAL** button again, and if the problem persists, select external calibration and contact the supplier.

### **10.12.2 Internal calibration (I-CAL)**

The balance calibrates itself through the internal reference mass **ONLY** upon the request of the user by pressing the **CAL** button. Before carrying out the internal calibration, ensure that no weight is loaded on the weighing pan.

### **10.12.3 External calibration (E-CAL)**

The balance will be calibrated by using the external reference mass. (Follow the procedures described in paragraph 8.1.2).

### **10.12.4 Technical calibration (TEC-CAL)**

This function allows the internal reference mass to be calibrated whenever assistance-control maintenance interventions make this necessary.

1. After having selected the **TEC-CAL** calibration mode, press the **CAL** button with the plate empty. The word “**CAL**” will be displayed.

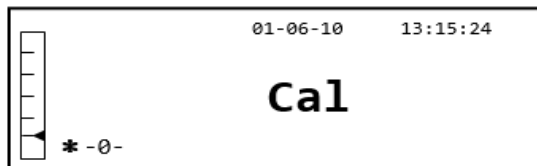



2. When the value of the calibration weight begins to flash, load the calibration weight on the weighing pan.

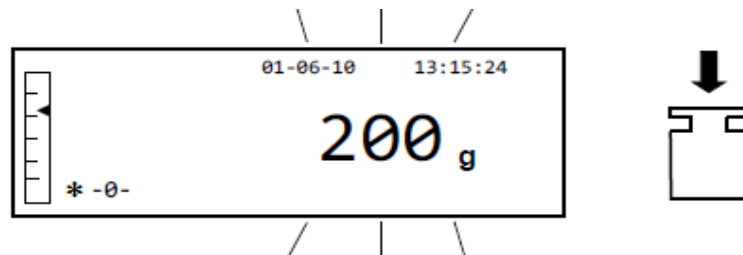

3. Wait for the calibrated weight to be displayed and the stability symbol to turn on, and then remove the weight from the pan.
4. When "0.000" is shown on the display, press the **PRINT** button for a prolonged manner until the beeping stops. The acquisition and automatic storage of the internal weight will now begin. During the acquisition cycle, the display will show the following flashing text:

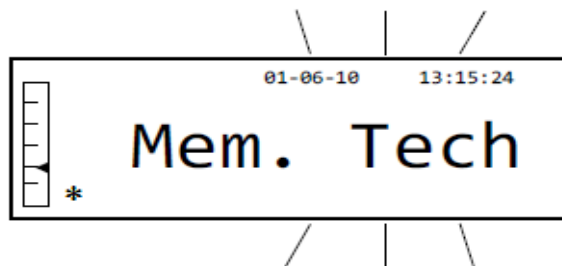

5. Once the internal calibration has been stored, the balance will return to the normal weighing condition.
6. Now re-enter the calibration menu as described in paragraph 10.12.1 and set the desired internal, automatic, or external calibration mode.



**WARNING:** this procedure must be carried out only using class E2 reference masses.

### 10.13 CALIBRATION DATA

This function allows the user to display the data relative to the last calibration carried out.

Date  
Calibration mode  
Correction

1. Select the calibration data parameter as described in paragraph 10.  
The data relative to the last calibration carried out will be shown on the display:

Calibration data	
10-06-10	
External calib.	2000.0g
Corr.:	1.2g

2. Press the **PRINT** button to print the calibration data.
3. Press the **ON/OFF** button to exit from the screen and return to the balance parameters menu. It will now be possible to select another parameter or return to weighing mode by pressing the **ON/OFF** button.

## 11.0 BALANCE PROGRAMS MENU

1. Press the **MENU** button with the weighing pan empty.
2. The following writing will be shown on the display:

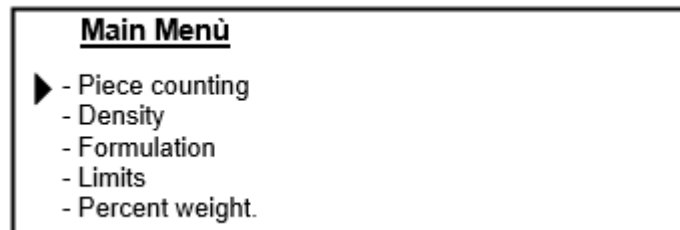

3. Now use the CAL and MENU buttons to navigate upward or downward in the menu of parameters.

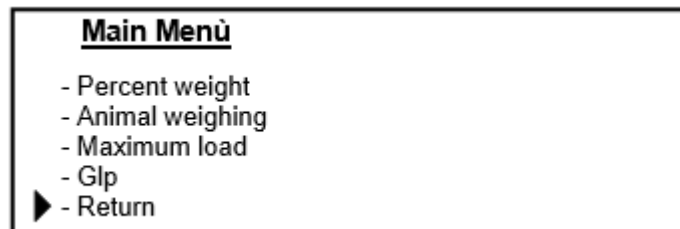

4. Position the cursor on the desired parameter and press the PRINT button to confirm the selection.
5. Press the ON/OFF button to exit from the menu or select the return function and press the PRINT button.

## 11.1 PIECE COUNTING FUNCTION

The piece counting program allows you to carry out a total count of the pieces after having carried out a sampling of pieces or having inserted the average unit weight for the piece.

1. Select the piece counting program as described in paragraph 10. The following screen will be shown on the display:



1. Select the number of pieces to put on the weighing pan as a sample, pressing in sequence the **MENU** button to increase and the **CAL** button to decrease.
2. Load an empty container (if required), then press the **PRINT** button to confirm. The choice of the number of pieces (10, 25, 50, 100, manual, see chapter 10.3) is a function of the weight of an individual piece. Load the empty container.
3. Load the number of pieces indicated on the display on the weighing pan and press the **PRINT** button.

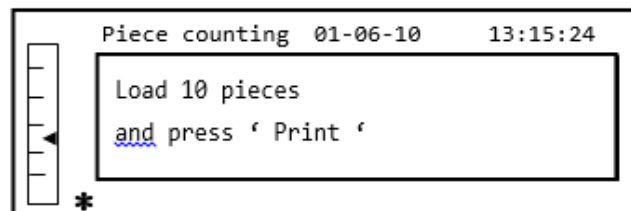

If there are enough samples (e.g. 10 as in the figure), the number of pieces loaded will appear on the display. It will now be possible to proceed with the counting of the pieces.

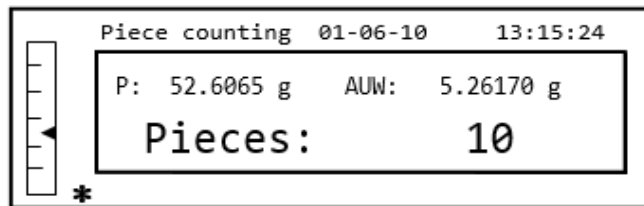

If the pieces to be counted have a weight that is too little with respect to the balance's resolution, an error message will be displayed. In this case it will be necessary to weigh on a balance with greater resolution.

If the weight of the samples is acceptable but not sufficient, the following message will be displayed: Add enough pieces so as to approximately double the quantity loaded on the plate, then press the **PRINT** button.

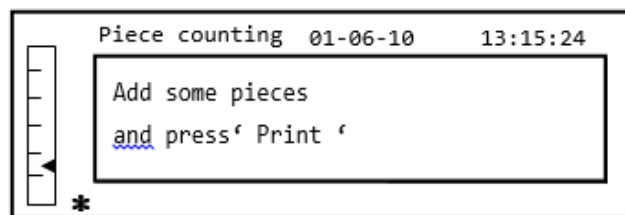

If the number of pieces is still insufficient, the message indicated above will be displayed again. Double the quantity of pieces loaded again.

Once a sufficient number of pieces has been reached, their number will be displayed and it will be possible to proceed with the counting, loading the pieces to be counted on the plate.

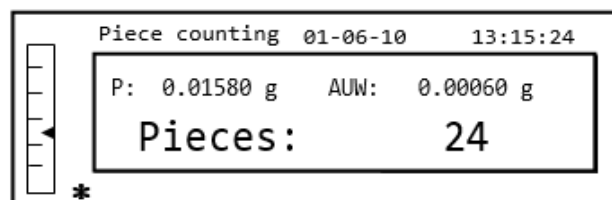

4. To exit from piece counting mode, press the **ON/OFF** button and the balance will return to the normal weighing conditions.

### **11.1.1 Manual insertion of the average unit weight**

This function allows the user to enter, when known, the average unit weight of the piece, thus avoiding the sampling of the pieces.

1. Select the piece counting program as described in paragraph 10. The following screen will be shown on the display:

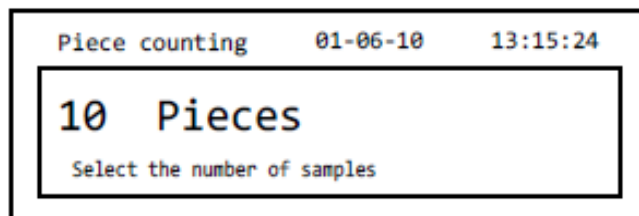

2. Press the **MENU** button until the following message appears on the display:

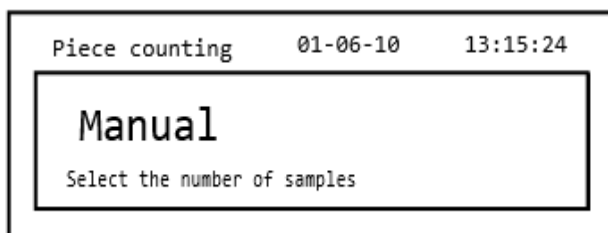

3. Then press the **PRINT** button to confirm.

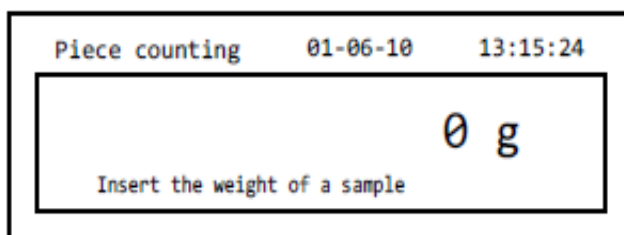

4. Insert the piece's unit weight in grams using the **CAL** and **MENU** buttons to increase and decrease the value, while pressing the **O/T** button to pass to the next value. To insert a decimal point, hold down the **CAL** button for a prolonged time. During the entering phase, the prolonged pressing of the **O/T** button allows you to delete the inserted value.

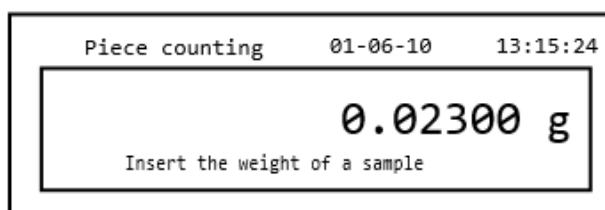

5. Press the **PRINT** button to confirm. If the piece entered is less than 100 times the resolution of the balance, an error message will be displayed. To exit without entering the weight, press the **ON/OFF** button.
6. If the weight is sufficient, "0" will be shown on the display; it is now possible to proceed with the counting, loading the pieces on the plate.

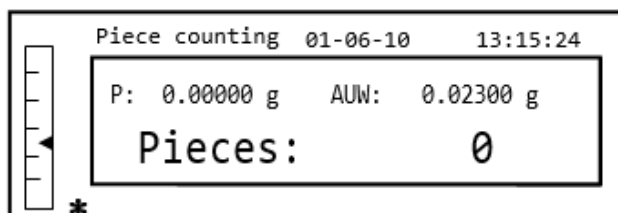

7. To exit from the piece counting function, press the **ON/OFF** button.

It is also possible to use the optional alphanumeric keyboard to insert the average unit weight of the sample. In this case, carry out the same procedure described above to enter manual insertion mode.

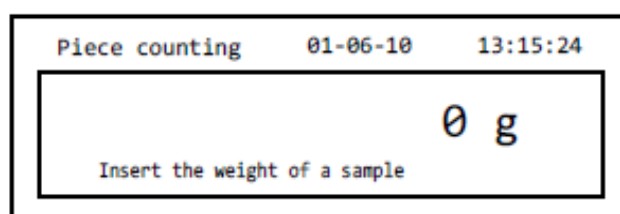

1. Insert the unit weight in grams of the sample by using the numeric keys from 0 to 9 and the decimal point.  
In case of error, press the **CLEAR** button and restart.

2. Press the **INSER** button to confirm.
3. If the piece entered is less than 100 times the resolution of the balance, an error message will be displayed.  
To exit without entering the weight, press **ESCAPE** (on the alphanumeric keyboard) or **ON/OFF**.
4. If the weight is sufficient, “0” will be shown on the display; it is now possible to proceed with the counting, loading the pieces on the plate.
5. To exit from the piece counting function, press the **ON/OFF** button.

### ***11.1.2 Automatic updating of the average unit weight***

After having carried out the sampling, the average unit weight can be updated in the following way.

1. Rather than loading all of the pieces to be counted, load an approximate number of pieces approximately double that of those loaded on the weighing pan and wait for the beep.
2. This procedure can now be repeated up to a maximum of 255 pieces or you can proceed with the normal counting of the pieces.  
This routine allows for a more accurate estimate of the average unit weight and a better precision in the counting of the pieces.

***NOTE: the automatic updating mechanism is not active if the sampling has been carried out through insertion of the average unit weight.***

## **11.2 PROGRAM FOR THE DETERMINATION OF THE DENSITY OF A SOLID OR A LIQUID**

The density calculation program allows the determination of the density of a solid or liquid through the use of the lower weighing hook or the density determination kit.

### ***11.2.1 Solid density determination***

1. Select the density program as described in paragraph 10. The following screen will be shown on the display:



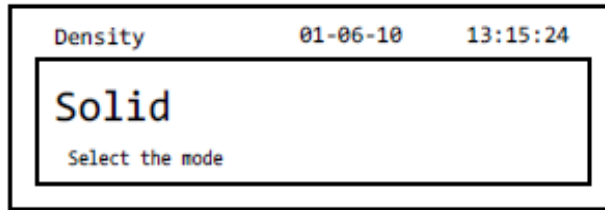

2. Then press the **PRINT** button to confirm the selection.
3. The density value of the liquid to be used will be displayed. The default value is equal to 1.0000 (distilled water at 20°C).

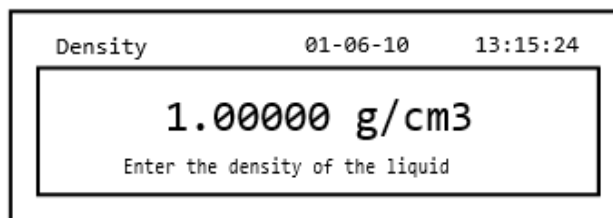

4. It is possible to insert a different value using the **CAL** and **MENU** buttons to increase and decrease the value, while pressing the **O/T** button to pass to the next value. During the menu input stage, prolonged pressure on the **O/T** button allows you to cancel the inserted value.

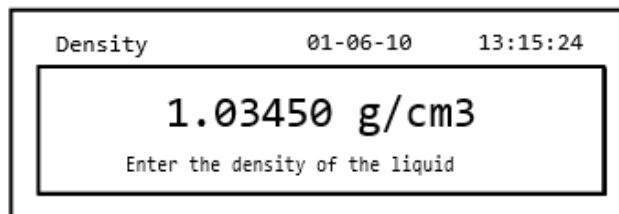

**Note: It is also possible to set the value using the optional alphanumeric keypad.**

5. Once the desired value has been set, press the **PRINT** button.
6. It will now ask you to weigh the solid in the air.

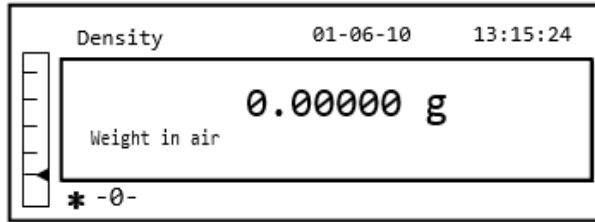

7. Press the tare, if necessary, and load the solid. Wait for the stability symbol to appear and press the **PRINT** button to acquire the value. The word 'wait...' will appear while the weight is being taken.
8. The weight of the solid in the liquid will then be requested. Carry out the tare of the drum in the liquid. Put the solid in the drum, immerse the solid, and wait for the stability indicator to appear. Then press the **PRINT** button. The word "wait..." will be displayed while the weight is being taken.

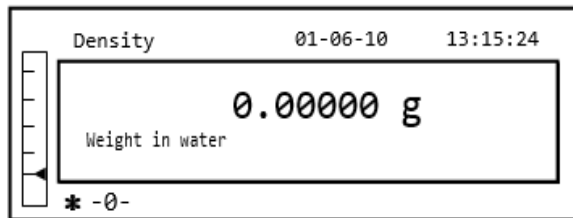

9. The result of the density calculation of the solid will now be displayed. If the balance is equipped with a printer, it will be possible to print the density value by pressing the **PRINT** button.

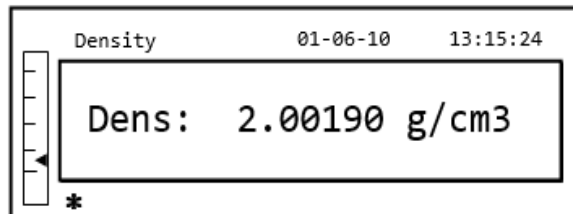

10. The following text will be shown on the display in case of error:

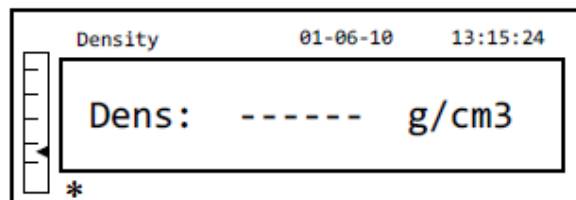

11. Now press the **ON/OFF** button to exit from the density function, or the **MENU** button to carry out the density measurement for another solid.

### 11.2.2 Liquid density determination

1. Select the density program as described in paragraph 10. The following screen will be shown on the display:

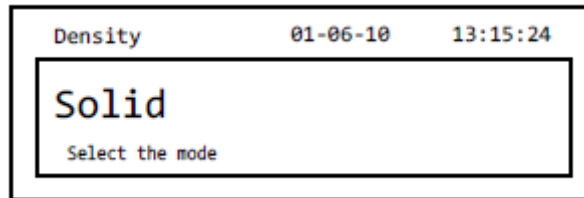

2. Press the **MENU** button select liquid mode. Then press the **PRINT** button to confirm.

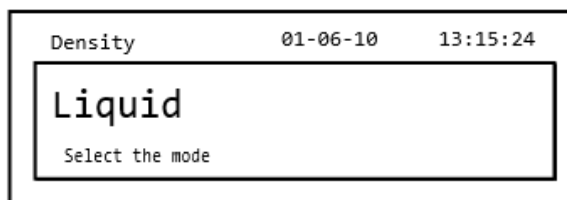

3. The default value of the solid's density will be displayed. The default value is equal to  $3.0000 \text{ g/cm}^3$ .

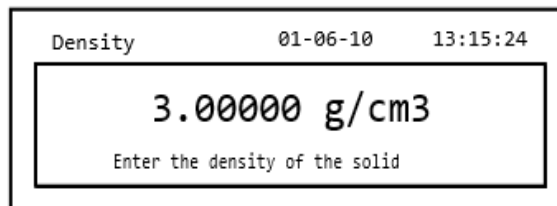

4. A different value can be entered by using the **CAL** and **MENU** buttons to increase and decrease the value, while pressing the **O/T** button to pass to the next value. During the menu input stage, prolonged pressure on the **O/T** button allows you to delete the inserted value.

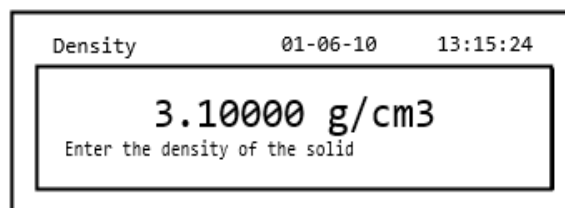

**Note: It is also possible to set the value using the optional alphanumeric keypad.**

5. Once the desired value has been set, press the **PRINT** button.

6. It will now ask you to weigh the dipstick in the air.

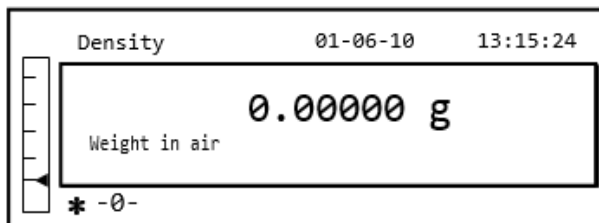

7. Press the tare, if necessary, and load the dipstick. Wait for the stability symbol to appear and press the **PRINT** button to acquire the value. The word 'wait...' will appear while the weight is being taken.

8. The weighing of the dipstick immersed in the liquid will then be requested. Then immerse the solid in the liquid, wait for the stability indicator to appear, and then press the **PRINT** button. The word 'wait...' will be displayed while the weight is being taken.

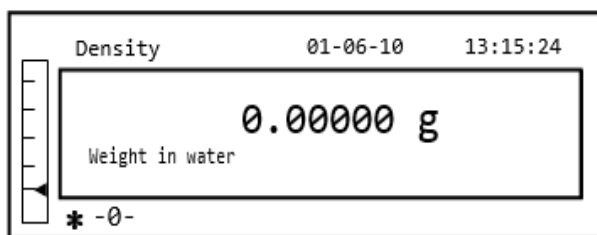

9. The result of the density calculation of the liquid will now be displayed. If the balance is equipped with a printer, it will be possible to print the density value by pressing the **PRINT** button.

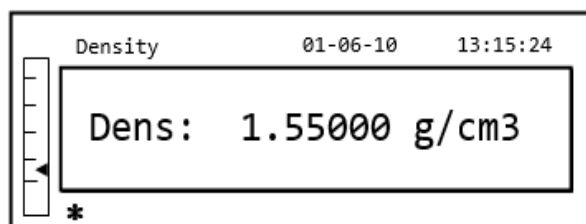

10. The following string will be shown on the display in case of error:

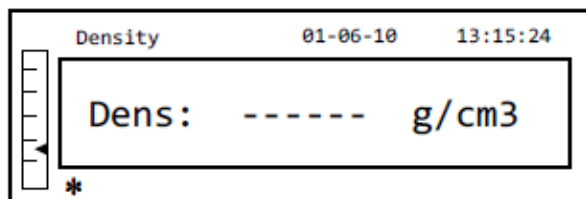

11. Now press the **ON/OFF** button to exit from the density function, or the **MENU** button to carry out the density measurement for another liquid.

### 11.3 FORMULATION FUNCTION

#### 11.3.1 Manual formulation

1. Select the formulation program as described in paragraph 10.  
The following screen will be shown on the display:

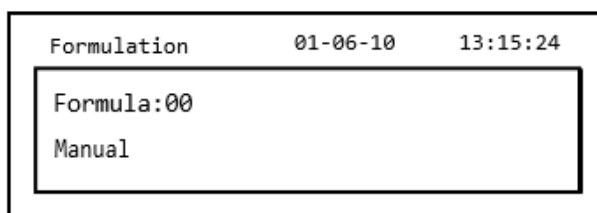

2. Then press the PRINT button to confirm the selection.

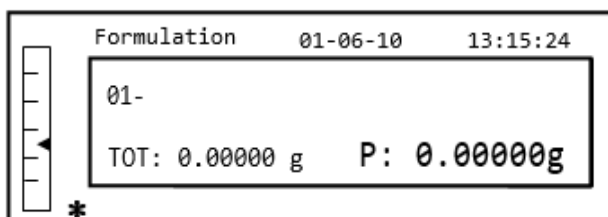

3. Press the tare, if necessary, and load the first ingredient.

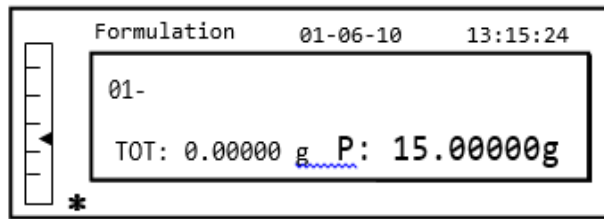

4. Then press the **PRINT** button to confirm.

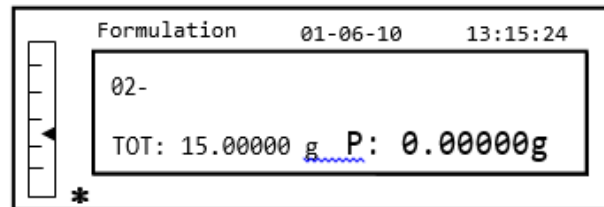

5. Press the tare, if necessary, and load the second ingredient.

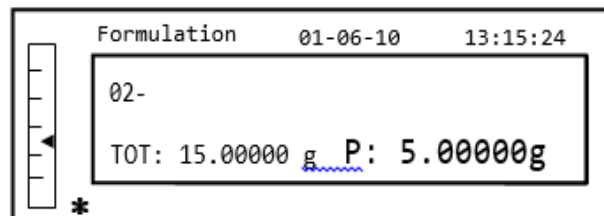

6. Then press the **PRINT** button to confirm.

7. Repeat the operation for a maximum number of 99 ingredients.

**Note: During the acquisition of the ingredient, the display of Err10 indicates a negative weight value. Check not to have made a mistake with the ingredient loading and zeroing procedure.**

8. To end, print the value of the individual components and the total value, and press and keep pressed the **PRINT** button until the beeping stops. The display will show the following screen:

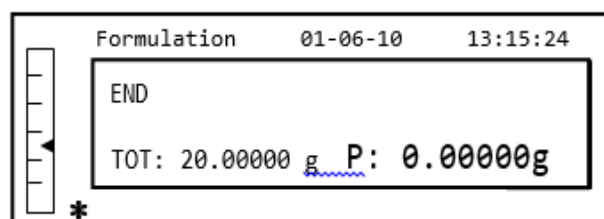

9. To exit from the screen and carry out a new formulation, press the **ON/OFF** button once. To exit from the program and return to the weighing screen, press the **ON/OFF** button two consecutive times.

### 11.3.2 Formula saving

1. Select the formulation program as described in paragraph 10. The following screen will be shown on the display:

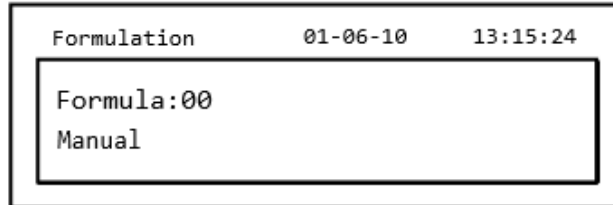

Formulation 01-06-10 13:15:24

Formula:00  
Manual

2. Select the number of the formula to save or modify using the **CAL** and **MENU** buttons to increase and decrease the value, after the word 'Formula'. Then press and keep pressed the **PRINT** button until the beeping stops to confirm the selection and enter the 'setup formula' menu.

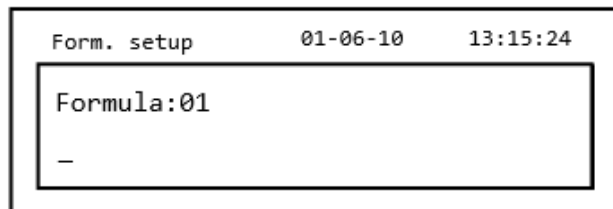

Form. setup 01-06-10 13:15:24

Formula:01  
-

3. Enter the name of the formula (it can be a series of numbers or letters, max 20 characters) using the **MENU** or **CAL** buttons to scroll all of the available characters, and the **TARE** button to pass to the next character. To select the uppercase or lowercase character, press and hold the **MENU** button until the beeping stops.

*Note: It is also possible to set the value using the optional alphanumeric keypad.*

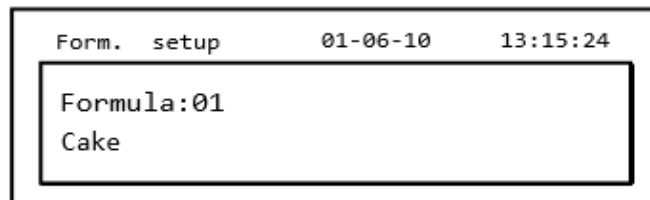

Form. setup 01-06-10 13:15:24

Formula:01  
Cake

4. Press the **PRINT** button to confirm.

Form. setup	01-06-10	13:15:24
Cake		
01 _		

5. Enter the name of the first component (it can be a series of numbers or letters, max 11 characters) using the **MENU** or **CAL** buttons to scroll through the available characters.

6. Then press the **PRINT** button to confirm and save the value.

Form. setup	01-06-10	13:15:24
Cake		
01- Flour	10.00000g	
T- =- 1.0 %	T+ = + 2.0 %	

7. Now enter the quantity of the component using the **MENU** or **CAL** buttons to increase or decrease the value while pressing the **O/T** button to pass to the next value and the **PRINT** button to pass to the next parameter.

8. Now enter the negative tolerance and press **PRINT** button to pass next parameter

9. Now enter the positive tolerance.

10. Then press the **PRINT** button to confirm and save the value.

11. Repeat the operation described from point 5 to point 10 to enter all of the desired components up to a maximum of 20.

12. After having entered all of the desired components press the **ON/OFF** button to exit from the formula saving procedure.



### 11.3.3 Formula recall

1. Select the formulation program as described in paragraph 10. The following screen will be shown on the display:

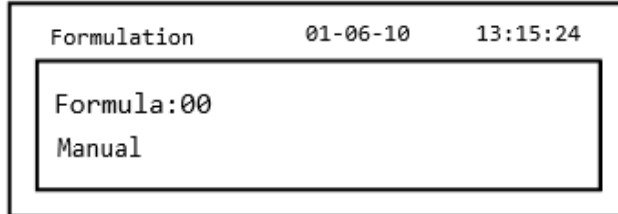

2. Choose the name of the formula (previously saved) using the **CAL** and **MENU** keys to scroll through the various formulas inserted.

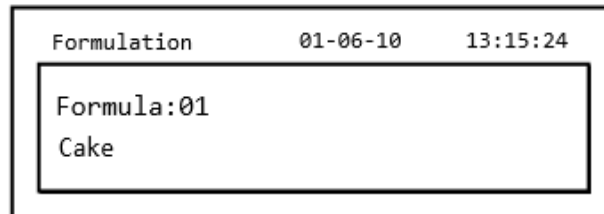

3. Then press the **PRINT** button to confirm the selection.

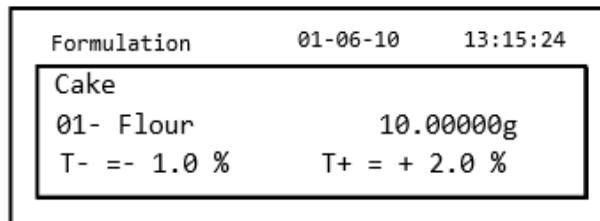

4. It will now be possible to display the various components and the relative quantities of the selected formula using the **MENU** and **CAL** buttons.

5. Press the **PRINT** button again to insert the constant multiplier.

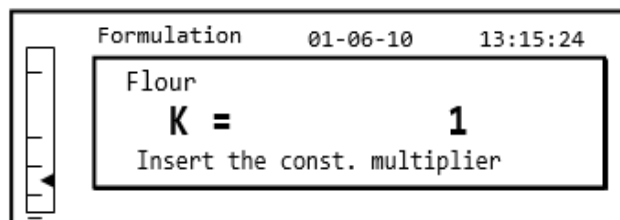

6. Now enter the multiplication constant K to determine the desired amount of product. Use the **MENU** or **CAL** buttons to increase or decrease the value.

**Example:** if the entered formula is for 100g of product, inserting K = 2 the values of all components will be recalculated to obtain a total amount of product equal to 200g.

7. Press the **PRINT** button again to begin weighing the various components. If necessary, carry out the tare operation before measuring out the quantity of component indicated at the top right of the display

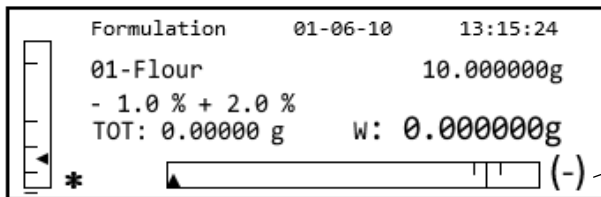

(-) means that weight is under the value  
 (+) means that weight is over the value  
 OK means that weight is inside values



To facilitate the dosing operation, when the value of the component is approaching the threshold of the acceptable value, the dosing bar will automatically zoom.

8. Then press the **PRINT** button to pass to the next component.

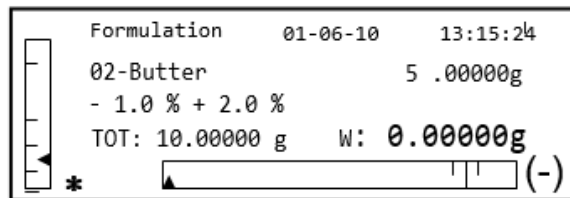

9. If necessary, carry out the tare operation before measuring out the quantity of component indicated at the top right of the display.

10. Then press the **PRINT** button to pass to the next component.

11. Repeat the procedure until all the components are entered, after which the weights of the single components measured and the total weight will be printed if the instrument is equipped with a printer. The display will show the following screen:

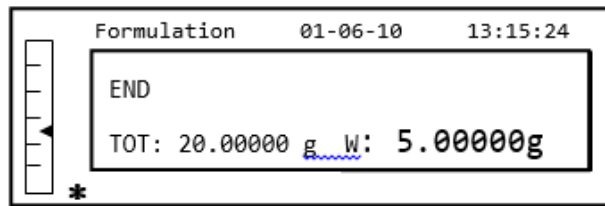

12. To exit from the screen and carry out a new formulation, press the **ON/OFF** button once. To exit from the program and return to the weighing screen, press the **ON/OFF** button two consecutive times.

To interrupt and exit from the formulation function at any time, press the **ON/OFF** button.

#### 11.4 MAX-MIN THRESHOLDS FUNCTION.

The thresholds function allows you to determine if the weight loaded on the weighing pan is above or below two thresholds pre-set by the user.

1. Select the thresholds function as described in paragraph 10. The following screen will be shown on the display:

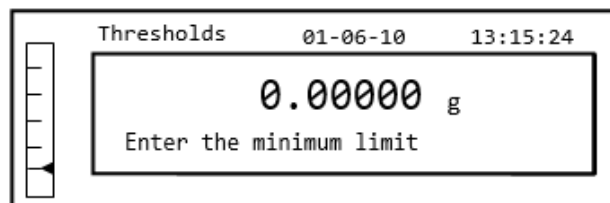

2. Enter the MINIMUM limit value by using the **CAL** and **MENU** buttons to increase and decrease the value, while pressing the **O/T** button to pass to the next number. During the entering phase, prolonged pressure on the **O/T** button allows you to delete the entered value.

3. Then press the **PRINT** button to confirm. The entered value will remain in memory until the balance is turned off.

4. The following screen will then be displayed.

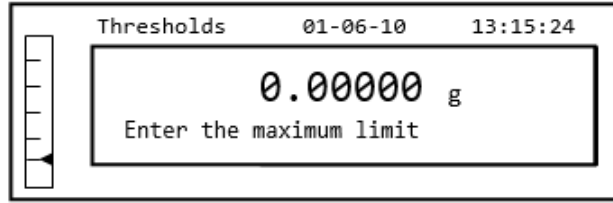

5. Now insert the MAXIMUM limit using the same procedure described for the insertion of the MINIMUM limit.
6. Then press the **PRINT** button to confirm. The entered value will remain in memory until the balance is turned off.

*Note: It is also possible to set the value by using the optional alphanumeric keypad.*

7. The following screen will then be displayed.

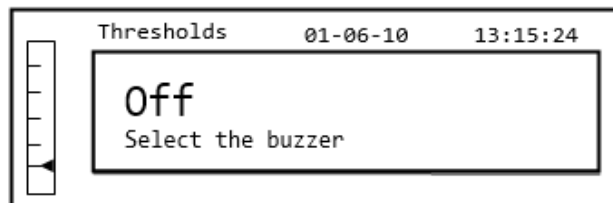

8. Through the **MENU** key, select whether the audible bleep is on or off when the weight is within the two set limits. Then confirm the selection by pressing the **ENTER** button.
9. If the thresholds have been inserted correctly, the balance will return to weighing mode with an indication of the threshold status (+ MAX threshold, - MIN threshold, **OK** within the two limits sets).

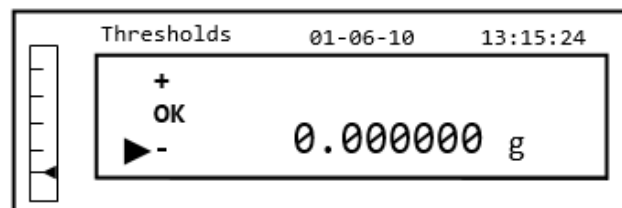

*NOTE: If the values have not been set correctly, the word ERROR 07 will be displayed.*

The thresholds function has three operating modes.

**A) *With both the limits set***

This mode allows the user to identify an acceptance range inserting a lower limit and an upper limit, in which the value of weight is considered ok, identified by the “OK” symbol that is displayed on the screen together with an acoustic signal (if activated). When the weight is under the value of the lower limit set, the symbol “L” is visualized on display, while if the value is over the upper limit set, the symbol “H” is shown on display.

**B) *With only the lower limit set***

When only the lower limit is set and the upper limit is left to zero, the weight is considered ok each time the value of weight is over the lower limit set, identified by the “OK” symbol that is visualized on the display together with the acoustic signal (if activated). When the weight is under the value of the lower limit set, the symbol “L” is shown on display.

**C) *With only the upper limit set***

When only the upper limit is set and the lower limit is left to zero, the weight is considered ok each time the value of weight is under the upper limit set, identified by the “OK” symbol that is visualized on the display together with the acoustic signal (if activated). When the weight is over the value of the upper limit set, the symbol “H” is shown on display.

**11.5 PERCENTAGE WEIGHING FUNCTION**

This function allows you to read the weight as a percentage of a reference weight. The reference weight is assumed as the 100% value (factory setting).

There are two modes for the acquisition of the reference weight – an automatic one (with reference weight), and a manual one (with the manual entry of the value of the reference weight).

### 11.5.1 Automatic mode with reference weight

1. Select the percentage weighing function as described in paragraph 10. The following screen will be shown on the display:

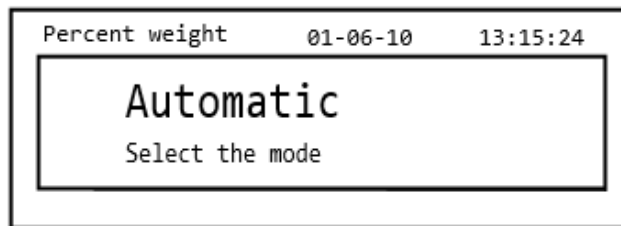

2. Confirm automatic mode by pressing the **PRINT** button.
3. The tare will be carried out and you will be asked to load the reference weight on the weighing pan.

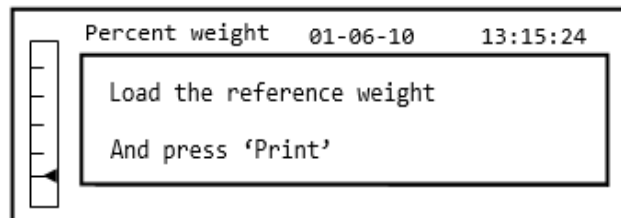

4. Load the reference weight on the weighing pan and then press the **PRINT** button; the word "**Wait**" will be shown. Once the weight is acquired, a screen with an indication of the weight loaded, reference weight, and percentage weight will be shown.

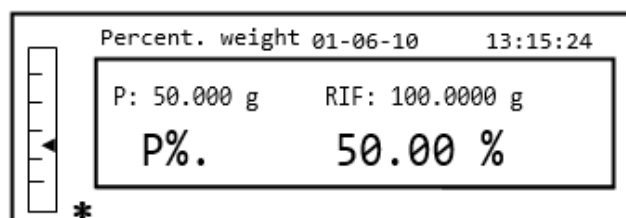

5. Now remove the reference weight, load the sample and read the percentage weight.
6. Press the **ON/OFF** button to exit from the percentage weighing function.

**NOTE:** If the reference weight entered is less than 10 displayed digits, the word **ERROR 07** will be shown.

### 11.5.2 Mode with manual insertion of the reference weight.

1. Select the percentage weight function as described in paragraph 10. The following screen will be shown on the display:

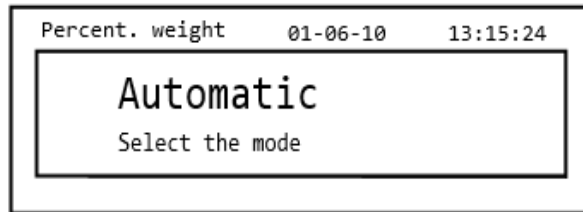

2. Press the **MENU** button to select manual mode

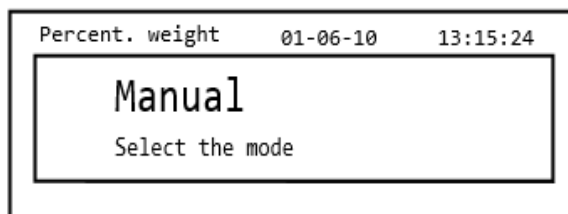

3. Confirm manual mode by pressing the **PRINT** button.

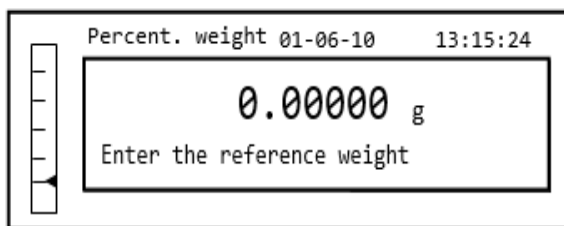

4. You can now enter the reference weight value, using the **CAL** and **MENU** keys to increase and decrease the value, while pressing the **O/T** button to pass to the next value. During the entry phase, holding down the **O/T** button allows you to delete the value entered. The value entered will remain in the memory until the balance is turned off. It is also possible to enter the value using the optional alphanumeric keypad.

5. After having inserted the desired reference weight value, press the **ENTER** key.

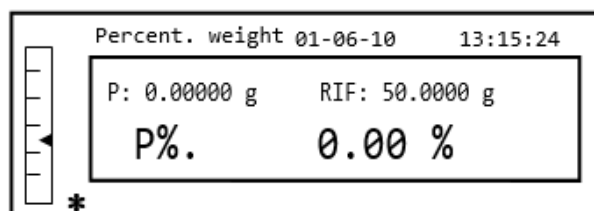

6. Now load the sample and read the percentage value.
7. Press the **ON/OFF** button exit from the percentage weighing function.

**NOTE:** *If the reference weight entered is less than 10 displayed digits, the word ERROR 07 will be shown.*

## 11.6 ANIMAL WEIGHING FUNCTION

The animal weighing function, allows you to acquire an averaged weight of moving objects or animals for a settable period of time.

1. Select the animal weighing function as described in paragraph 10. The following screen will be shown on the display:

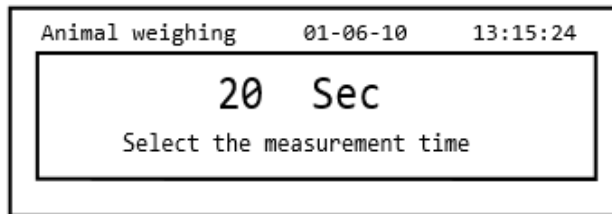

2. Set the desired time from 5 to 90 seconds, using the **MENU** key to decrease and **CAL** to increase the time value. Then confirm by pressing the **PRINT** button.

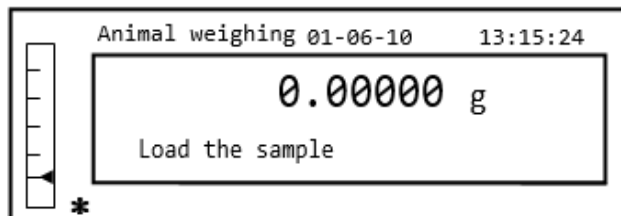

3. Load the sample to be weighed on the weighing pan and press the **PRINT** button; the value of the current weight and the set sampling countdown time will be displayed.

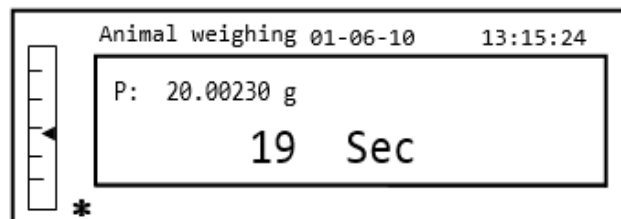

4. With the weight and time set, the weight will be shown on the display with an indication of the average weight detected.



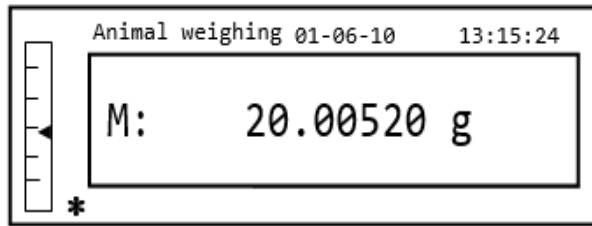

5. Press the **ON/OFF** button once to carry out another measurement, or twice to exit from the function.

### 11.7 MAXIMUM LOAD FUNCTION

The “maximum load” function allows you to measure the maximum breakage load of a solid.

1. Select the maximum load function as described in paragraph 10.  
A tare will automatically be carried out and the following screen will be shown on the display with an indication of the maximum load function at the top left:

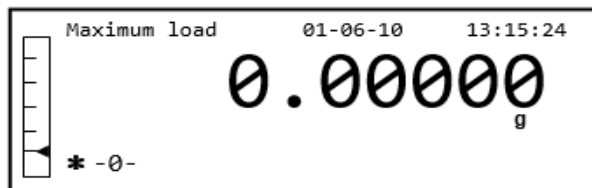

2. The breakage weight can now be detected.

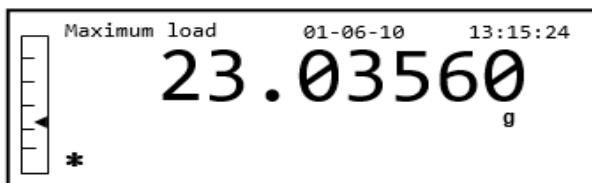

3. Press the **TARE** button to carry out another measurement.
4. Press the **ON/OFF** button to exit from the maximum load function.

## 11.8 GLP FUNCTION (GOOD LABORATORY PRACTICES)

The “GLP” function allows you to save the identifying parameters of the instrument and operator, to be able to print them along with the value of the test results.

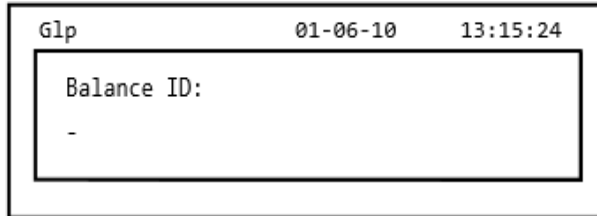

A screenshot of a device's GLP function screen. At the top, it displays 'Glp', the date '01-06-10', and the time '13:15:24'. Below this, there is a rectangular input field labeled 'Balance ID:' containing a hyphen '-'.

1. Select the GLP function as described in paragraph 10. The following screen will be shown:
2. Enter the balance ID (it can be a series of numbers or letters, max 18 characters) using the **MENU** and **CAL** buttons to scroll through all of the available characters. To select uppercase or lowercase characters, press and hold the **MENU** button until the beeping stops.

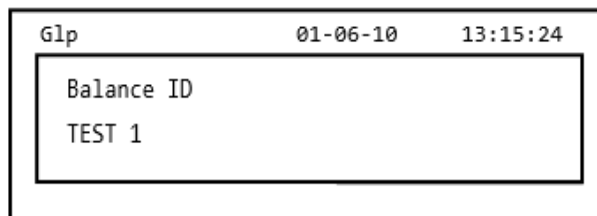

A screenshot of the same device's GLP function screen. The 'Balance ID' field now contains the text 'TEST 1'.

*Note: It is also possible to set the value by using the optional alphanumeric keypad.*

3. Enter the user ID (it can be a series of numbers or letters, max 18 characters) using the **MENU** and **CAL** buttons to scroll through all of the available characters.

*Note: It is also possible to set the value by using the optional alphanumeric keypad.*

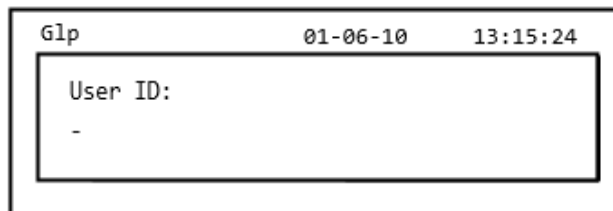

A screenshot of the device's GLP function screen. At the top, it displays 'Glp', the date '01-06-10', and the time '13:15:24'. Below this, there is a rectangular input field labeled 'User ID:' containing a hyphen '-'.

4. Confirm by pressing the **PRINT** button.

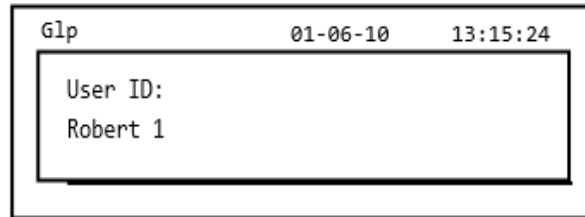

A screenshot of a device screen with a black border. At the top, it displays 'Glp' on the left, '01-06-10' in the center, and '13:15:24' on the right. Below this, there is a rectangular input field with a black border. Inside the field, the text 'User ID:' is on the first line and 'Robert 1' is on the second line.

5. Enter the project identifier (it can be a series of numbers or letters, max 18 characters) using the **MENU** and **CAL** buttons to scroll through all of the available characters.

*Note: It is also possible to set the value by using the optional alphanumeric keypad.*

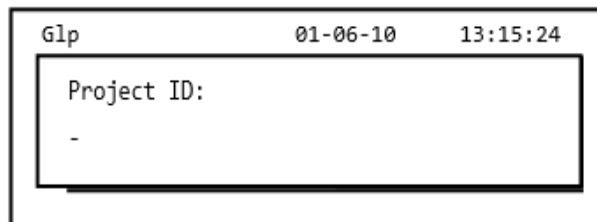

A screenshot of a device screen with a black border. At the top, it displays 'Glp' on the left, '01-06-10' in the center, and '13:15:24' on the right. Below this, there is a rectangular input field with a black border. Inside the field, the text 'Project ID:' is on the first line and '-' is on the second line.

6. Then confirm all of the data entered by pressing and holding the **PRINT** button until the audible beeping stops.

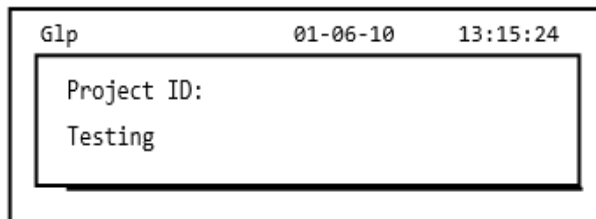

A screenshot of a device screen with a black border. At the top, it displays 'Glp' on the left, '01-06-10' in the center, and '13:15:24' on the right. Below this, there is a rectangular input field with a black border. Inside the field, the text 'Project ID:' is on the first line and 'Testing' is on the second line.

7. The balance will automatically return to the weighing screen.

## 12.0 RS232 INTERFACE FEATURES

### 12.1 GENERAL FEATURES

The balance transmits the value shown on the display following serial RS232C standard, allowing the scale to transmit the value of weight to a PC monitor or to a serial printer. In the case of connection to a PC, it will be possible to select the transmission in continuous mode or transmission at user command, through pressing of the PRINT button. The balance is also capable of receiving commands, always through the standard RS232C, that allows performing all the functions available through the keyboard of PC itself. The speed of transmission and reception can be selected, as described previously, to 1200, 2400, 4800, and 9600 baud. The character format is of 8 bit preceded by one bit of start followed by a bit of stop. Parity is not considered.

### 12.2 DIAGRAM OF CONNECTOR

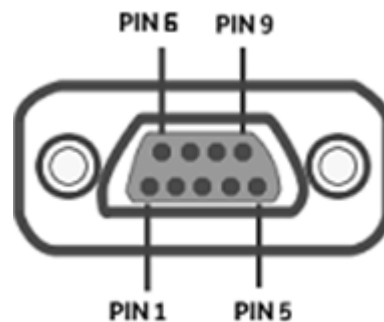
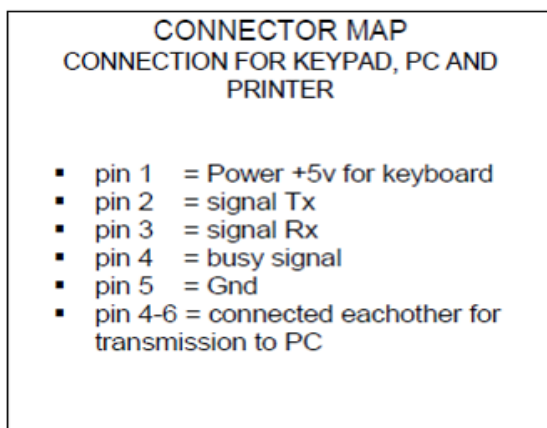

### 12.3 CONNECTION OF THE BALANCE TO A COMPUTER

To receive/transmit data, ensure the connector is wired as shown, to connect the balance to the serial port of your Personal Computer as shown below:

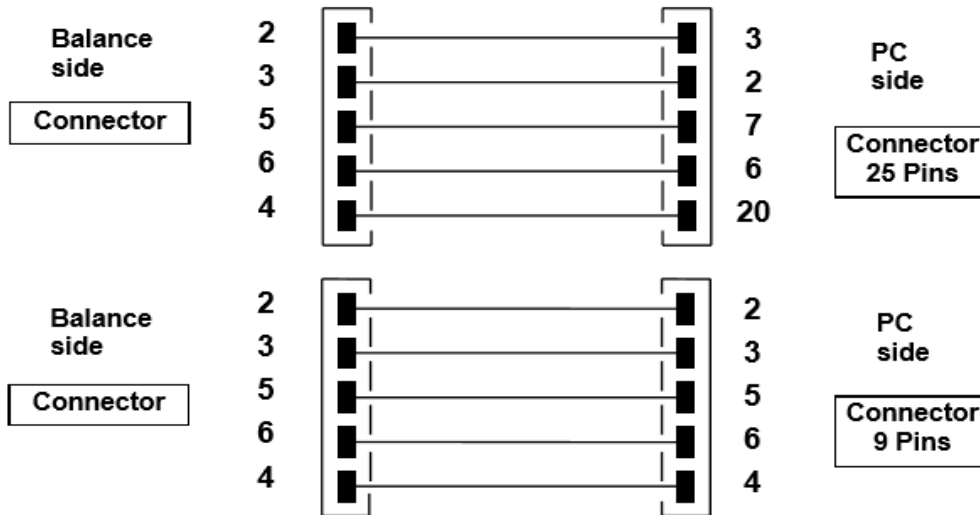

There are three ways of transmission in which the Balance and the computer can be connected:

- Continuous transmission of weight data (continuous mode must be set from the menu as explained in the paragraph 10.2).
- On demand transmission of weight data (on demand mode must be set from the menu as explained in the paragraph 10.2).
- On demand transmission with GLP of weight data (on demand mode with GLP must be set from the menu as explained in the paragraph 10.2).

In all the modes, it is possible to execute all the balance's functions directly from the computer's keyboard, transmitting to balance the ASCII codes as shown in the table below.

CODE	1 <sup>st</sup> FUNCTION (SINGLE PRESS)
"T" = H54	TARE
"C" = H43	CALIBRATION
"E" = H45	ENTER
"M" = H4D	MENU
"O" = H4F	ON/OFF

CODICE	2 <sup>nd</sup> FUNCTION (PROLONGED PRESS)
"t" = H74	TARE
"c" = H63	CALIBRATION
"e" = H65	ENTER
"m" = H6D	MENU
"o" = H6F	ON/OFF

### 12.3.1 Continuous transmission mode

String transmitted is composed by the following 14 characters:

- First character: weight sign (blank or -)
- Second to ninth character: weight or other data
- Tenth to twelfth character: weight unit symbol
- Thirteenth character: stability indicator
- Fourteenth character: carriage return
- Fifteenth character: line feed

Eventual non-significative zero are put as spaces.

In the following table the various transmission formats are shown:

Weight mode (valid for both continuous and on demand transmission)

1°	2°	3°	4°	5°	6°	7°	8°	9°	10°	11°	12°	13°	14°	15°
Sign	weight							weight unit			Stability	CR	LF	

### 12.3.2 On demand transmission mode

When operating in "on demand mode", the transmitted data to the computer does not only include information on the weight value but also date/time and other information, the output depends on the function, the balance is currently set to, being transmitted to the computer.

The data transmitted in each possible situation is shown below:

**WEIGHT:**

```
-----
03-04-11 10:13:44
-----
Weight:   0.00 g
```

---

**PIECE COUNTING:**

```
-----
03-04-11 10:49:28
----- Pcs.:   10
Weight:  100.02 g
MPW:    10.00 g
```

---

**DENSITY:**

-----  
03-04-11 10:51:15  
-----

d: 1.4504 g/cm<sup>3</sup>

---

**FORMULATION:**

-----  
03-04-11 10:54:57  
-----

Manual

1. 31.05 g
2. 100.02 g
3. 26.89 g

----- **NOTE: To transmit the print of total of weights, press and keep pressed the PRINT button T =**  
157.96 g

---

**THRESHOLDS:**

Value under threshold	Value inside thresholds	Value over threshold
----- 03-04-11 11:02:19 -----	----- 03-04-11 11:01:50 -----	----- 03-04-11 11:01:50 -----
Lim.1 : 10.00 g Lim.2 : 100.00 g Weight: -0.01 g TEST: KO! ---	Lim.1 : 10.00 g Lim.2 : 100.00 g Weight: 31.08 g TEST: OK!	Lim.1 : 10.00 g Lim.2 : 100.00 g Weight: 131.10 g TEST: KO! +++

---

**PERCENTUAL WEIGHT**

-----  
03-04-11 11:58:39  
----- Perc. 100.0 %  
Weight: 18.69 g  
Refer.: 18.69 g

---

**ANIMAL WEIGHING:**

-----  
03-04-11 12:01:06  
-----

Time = 20 Sec  
M: 56.53 g

---

**MAXIMUM LOAD:**

-----  
03-04-11 12:01:57  
----- Max.: 2.76 g

---

### 12.3.3 On demand transmission with G.L.P.

In the "on demand transmission" with G.L.P., the data transmitted to the computer is the same as described as in the "on demand transmission" without G.L.P. mode but with adding the G.L.P. parameters before of each transmission, as described below:

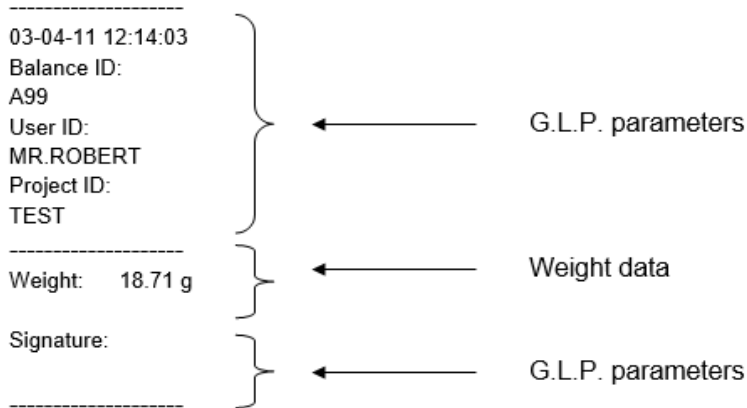

### 12.4 CONNECTION OF BALANCE WITH SERIAL PRINTER

It is possible to connect the balance to a peripheral printer.

To print the weight, connect the connector of the balance to the serial printer as shown in the scheme below:

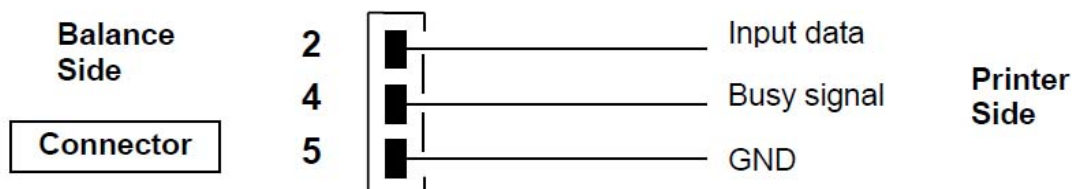

Here you can find description of the several modes of printing that can be selected:

- Print of weight data with a generic serial printer (from the menu, set the generic printing mode as described in the paragraph 10.2 and manage the busy signal).
- Print of weight data together with GLP indications with generic serial printer (from the menu, set the generic printing-GLP mode as described in the paragraph 10.2 and manage the busy signal)
- Print of weight data with printer model TLP50 (from the menu, set the printer TLP mode as described in the paragraph 10.2).
- Print of weight data together with GLP indications with printer model TLP50 (from the menu, set the printer TLP - GLP mode as described in the paragraph 10.2).

**Note:** In all different printing modes just described, if the weight is not stable during transmission of data to printer, an audible bleep is emitted and ERR05 is displayed and weight is not printed.



### 12.4.1 Print formats

Here is described the different types of print, depending on the print mode and on the function selected:

#### Generic printing or TLP 50 printer

##### Weighing mode:

-----  
03-04-11 10:13:44  
-----

Weight: 0.00 g

---

##### Piece counting:

-----  
03-04-11 10:49:28  
-----

----- Pcs.: 10

Weight: 100.02 g

MPW: 10.00 g

---

##### Density:

-----  
03-04-11 10:51:15  
-----

d: 1.4504 g/cm<sup>3</sup>

---

##### Formulation:

-----  
03-04-11 10:54:57  
-----

Manual

1. 31.05 g

2. 100.02 g

3. 26.89 g

----- **NOTE: To transmit the print of total of weights, press and keep pressed the PRINT button T =**

157.96 g

---

##### Thresholds:

Value under threshold

Value inside thresholds

Value over threshold

-----  
03-04-11 11:02:19  
-----

-----  
03-04-11 11:01:50  
-----

-----  
03-04-11 11:01:50  
-----

Lim.1 : 10.00 g

Lim.1 : 10.00 g

Lim.1 : 10.00 g

Lim.2 : 100.00 g

Lim.2 : 100.00 g

Lim.2 : 100.00 g

Weight: -0.01 g

Weight: 31.08 g

Weight: 131.10 g

TEST: KO! ---

TEST: OK!

TEST: KO! +++

---

##### Percentage weight:

-----  
03-04-11 11:58:39  
-----

----- Perc. 100.0 %

Weight: 18.69 g

Refer.: 18.69 g

---

**Animal weighing:**

-----  
03-04-11 12:01:06  
-----

Time = 20 Sec

M: 56.53 g

---

**Maximum load:**

-----  
03-04-11 12:01:57  
-----



----- Max.: 2.76 g

**12.4.2 Generic printer or TLP 50 printer with GLP**

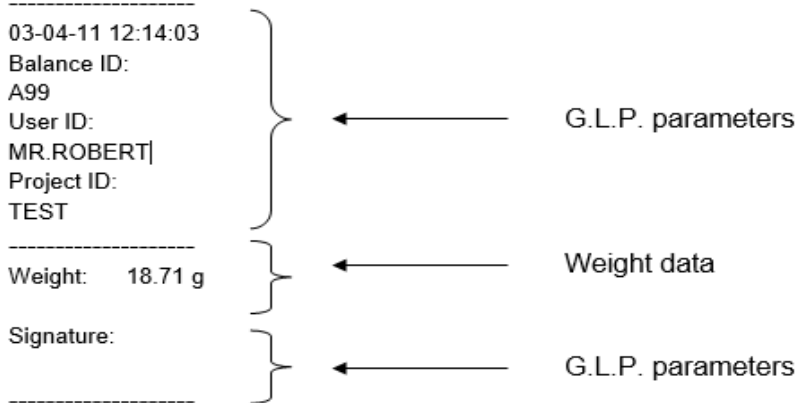
In the print mode with G.L.P., the printed data is the same as shown in the print mode without G.L.P. but with the G.L.P. parameters added as shown below:



## 13.0 ERROR CODES

ERROR MESSAGE ON DISPLAY	MEANING	POSSIBLE SOLUTIONS
ERR01	Weight not stable after operation of tare	Protect the balance from air flows or from vibrations from unstable work surface.
ERR02	impossible to start the calibration due to instability of the balance	Protect the balance from air flows or from vibrations from unstable work surface.
ERR03	calibration weight not correct or balance unstable	Calibrate with correct weight or protect the balance from environment disturbance. <b>In models with internal calibration</b> remove the screw in the left lower part of the balance (see par5)
ERR04	weight of samples for the piece counting function not adequate or unstable	Select a bigger number of samples or protect the balance from vibrations.
ERR05	impossible to print because of weight unstable	Protect the balance from environment disturbance.
ERR06	Weight cannot get stable in density mode	Protect the balance from environment disturbance.
ERR07	Weight cannot get stable in percentual weighing mode	Protect the balance from environment disturbance.
ERR08	Anomaly on autocalibration motor	Contact service staff
ERR09	Weight cannot get stable in formulation mode	Protect the balance from environment disturbance.
ERR10	Weight of component out of tolerance in formulation mode	Reduce quantity
ERR F	Flash memory damaged	Ask assistance from authorized service staff
“UNLOAD”	weight loaded on the pan or pan not positioned properly	Remove the weight from the pan or position properly the pan and underpan.
“CAL But”:	the balance requires recalibration	Unload weights, if any, on the pan, and press the CAL button
	Over-range condition	Unload the weights loaded on the pan
	Under-range condition	Locate the pan and underpan correctly.

## 14.0 MAINTENANCE AND CARE

Regular maintenance of yours balance guarantees accurate measurements.

### **Cleaning**

Before cleaning the balance unplug the power supply of the balance from the electrical supply in your room. Do not use aggressive cleaning product (such as solvents or similar), use a damp cloth with soft detergent. Do not allow liquids to go inside the instrument during the cleaning. Wipe the balance with a soft cloth. Remaining samples or powder can be removed using a small soft brush.

### **Safety checks**

Safety of the instrument is not guaranteed when:

- The balance power supply is clearly damaged
- The balance power supply is not working in the designed manner
- The balance power supply is stored for long time in harsh environmental conditions. (e.g. humidity, temperature)

In these instances refer to the service department, where specialized technicians will assist in arrangements to return the instrument for repairs and assessment and then advise on the best course of action.

## 15.0 QUICK GUIDE TO BALANCE PARAMETER'S SETUP

To enter the balance parameters setup menu, press and keep pressed the **MENU** button until the buzzer is silent.

Use the **MENU** button to go to next parameter, use the **CAL** button to go to previous parameter and the **PRINT** button to confirm the choice. To escape from menu, press and keep pressed the **MENU** button until the acoustic alarm gets mute.

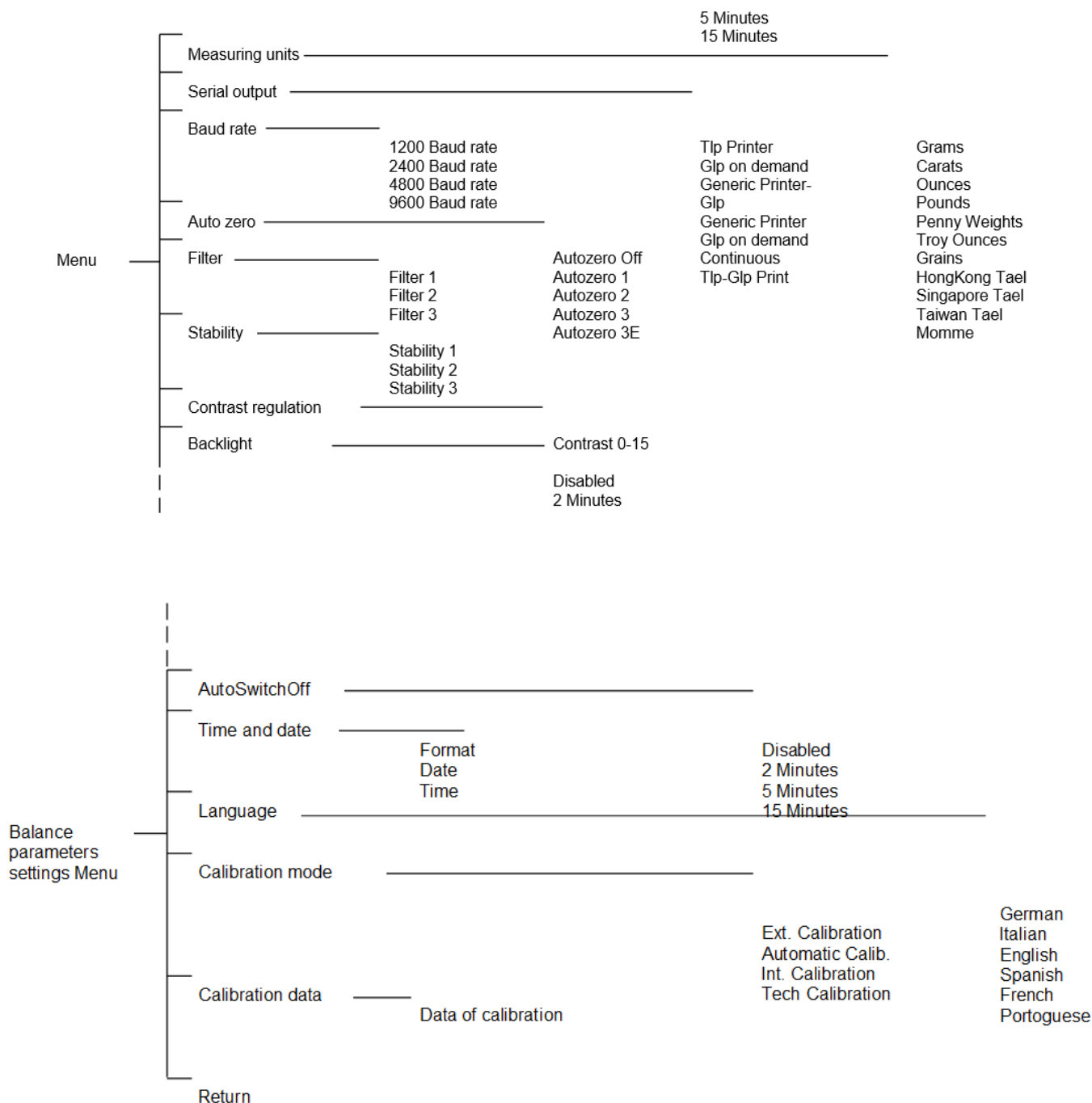

## 16.0 BALANCE TECHNICAL CHARACTERISTICS

All the models listed are only for internal use. Maximum altitude using limit: 4000m.  
Pollution level: 2. Over voltage category: II

Power supply provided:	INPUT: 230V ~ 50Hz o 115V ~ 60Hz, OUTPUT: 24V DC 550mA, Max power absorbed 13.2VA-
Environment conditions adaption:	Filters selection
Autozero:	Selectable from Menu
Serial output:	RS232C
Operating temperature:	+5°C - +35°C



## **WARRANTY INFORMATION**

Adam Equipment offers Limited Warranty (Parts and Labour) for the components failed due to defects in materials or workmanship. Warranty starts from the date of delivery.

During the warranty period, should any repairs be necessary, the purchaser must inform its supplier or Adam Equipment Company. The company or its authorised Technician reserves the right to repair or replace the components at any of its workshops depending on the severity of the problems. However, any freight involved in sending the faulty units or parts to the service centre should be borne by the purchaser.

The warranty will cease to operate if the equipment is not returned in the original packaging and with correct documentation for a claim to be processed. All claims are at the sole discretion of Adam Equipment.

This warranty does not cover equipment where defects or poor performance is due to misuse, accidental damage, exposure to radioactive or corrosive materials, negligence, faulty installation, unauthorised modifications or attempted repair or failure to observe the requirements and recommendations as given in this User Manual. Additionally rechargeable batteries (where supplied) are not covered under warranty.

Repairs carried out under the warranty does not extend the warranty period. Components removed during the warranty repairs become the company property.

The statutory right of the purchaser is not affected by this warranty. The terms of this warranty is governed by the UK law. For complete details on Warranty Information, see the terms and conditions of sale available on our web-site.



## WEEE 2012/19/EU

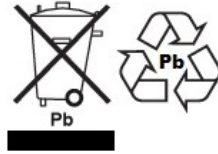

This device may not be disposed of in domestic waste. This also applies to countries outside the EU, per their specific requirements. Disposal of batteries (if fitted) must conform to local laws and restrictions.

Cet appareil ne peut être éliminé avec les déchets ménagers. L'élimination de la batterie doit être effectuée conformément aux lois et restrictions locales.

Dieses Gerät nicht mit dem Hausmüll entsorgt.

Dispositivo no puede ser desechado junto con los residuos domésticos

Dispositivo non può essere smaltito nei rifiuti domestici.

## FCC / IC CLASS A DIGITAL DEVICE EMC VERIFICATION STATEMENT

NOTE: This equipment has been tested and found to comply with the limits for a Class A digital device, pursuant to Part 15 of the FCC rules and Canadian ICES-003/NMB-003 regulation. These limits are designed to provide reasonable protection against harmful interference when the equipment is operated in a commercial environment. This equipment generates, uses and can radiate radio frequency energy and, if not installed and used in accordance with the instruction manual, may cause harmful interference to radio communications. Operation of this equipment in a residential area is likely to cause harmful interference in which case the user will be required to correct the interference at his own expense..



Adam Equipment products have been tested with, and are always supplied with mains power adaptors which meet all legal requirements for the intended country or region of operation, including electrical safety, interference and energy efficiency. As we often update adaptor products to meet changing legislation it is not possible to refer to the exact model in this manual. Please contact us if you need specifications or safety information for your particular item. Do not attempt to connect or use an adaptor not supplied by us.



**ADAM EQUIPMENT** is an ISO 9001:2008 certified global company with more than 40 years' experience in the production and sale of electronic weighing equipment.

Adam products are predominantly designed for the Laboratory, Educational, Health and Fitness, Retail and Industrial Segments. The product range can be described as follows:

- Analytical and Precision Laboratory Balances
- Compact and Portable Balances
- High Capacity Balances
- Moisture analysers / balances
- Mechanical Scales
- Counting Scales
- Digital Weighing/Check-weighing Scales
- High performance Platform Scales
- Crane scales
- Mechanical and Digital Electronic Health and Fitness Scales
- Retail Scales for Price computing

For a complete listing of all Adam products visit our website at [www.adamequipment.com](http://www.adamequipment.com)

<p><b>Adam Equipment Co. Ltd.</b> Maidstone Road, Kingston Milton Keynes MK10 0BD UK Phone:+44 (0)1908 274545 Fax: +44 (0)1908 641339 e-mail: <a href="mailto:sales@adamequipment.co.uk">sales@adamequipment.co.uk</a></p>	<p><b>Adam Equipment Inc.</b> 1, Fox Hollow Rd. 06478  USA Phone: +1 203 790 4774 Fax: +1 203 792 3406 e-mail: <a href="mailto:sales@adamequipment.com">sales@adamequipment.com</a></p>	<p><b>AE Adam GmbH.</b> Instenkamp 4 D-24242 Felde  Germany Phone +49 (0)4340 40300 0 Fax: +49 (0)4340 40300 20 e-mail: <a href="mailto:vertrieb@eadam.de">vertrieb@eadam.de</a></p>
<p><b>Adam Equipment S.A. (Pty) Ltd.</b> 7 Megawatt Road, Spartan EXT 22 Kempton Park, Johannesburg, Republic of South Africa  Phone +27 (0)11 974 9745 Fax: +27 (0)11 392 2587 e-mail: <a href="mailto:sales@adamequipment.co.za">sales@adamequipment.co.za</a></p>	<p><b>Adam Equipment (S.E. ASIA) PTY Ltd</b> 2/71 Tacoma Circuit CANNING VALE 6155 Perth Western Australia  Phone: +61 (0) 8 6461 6236 Fax +61 (0) 8 9456 4462 e-mail: <a href="mailto:sales@adamequipment.com.au">sales@adamequipment.com.au</a></p>	<p><b>Adam Equipment (Wuhan) Co. Ltd.</b> A Building East Jianhua Private Industrial Park Zhuanyang Avenue Wuhan Economic &amp; Technological Development Zone 430056 Wuhan P.R.China Phone: + 86 (27) 59420391 Fax + 86 (27) 59420388 e-mail: <a href="mailto:info@adamequipment.com.cn">info@adamequipment.com.cn</a></p>

© Copyright by Adam Equipment Co. All rights reserved. No part of this publication may be reprinted or translated in any form or by any means without the prior permission of Adam Equipment.

Adam Equipment reserves the right to make changes to the technology, features, specifications and design of the equipment without notice.

All information contained within this publication is to the best of our knowledge timely, complete and accurate when issued. However, we are not responsible for misinterpretations which may result from the reading of this material.

The latest version of this publication can be found on our Website.

[www.adamequipment.com](http://www.adamequipment.com)

